

**Village of Somers
7511 12th Street
Somers, WI 53171**

**Village Board Meeting
Agenda
Tuesday, March 11th, 2025
5:30 p.m.**

Village Board Meeting:	
Item #	
1	Call to order
2	Pledge of Allegiance
3	Consent and Approval of Minutes of Regular meetings on February 25 th , 2025, Vouchers dated February 27 th , 2025 and March 6 th , 2025, January 2025 Building Report and February 2025 Building Report
4	Correspondence:
5	Citizens Comments
6	President and Trustee Comments
7	Action on whether to direct staff and Attorney Davison to include the installation of the proposed water main for Shoreland Lutheran High School Federation Development Agreement for proposed project on Parcel # 82-4-222-084-0272
8	Discussion and possible action on Change Order #2 from August Winters & Sons, Inc. to increase the contract amount by \$5,554.00 for work on the 45th Avenue Lift Station and 63rd Avenue Lift Station 2023 UD #1 Capital Improvement Project
9	Action on request from Dimitri Fridman to build a berm at residence located at 343 Sheridan Road
10	Action on request for approval of a Recurring Special Event Application from the J. Smith Farms, Inc. (Jerry Smith Farm) located at 7150 18th Street
11	Action on request for approval of a Recurring Special Event Application from the Petrifying Springs Beer Garden LLC located at Petrifying Springs County Park Pavilion #1 7th Street
12	Action on request for approval of a Recurring Special Event Application from the Hyslop Foundation, Inc. (Hawthorn Hollow Nature Sanctuary & Arboretum) located at 880 Green Bay Road

13	Action on request to Vacate Public Right of Way from Bear Development on former Willow Creek Condominium project (Parcels 82-4-222-151-0560, 82-4-222-151-0561, 82-4-222-151-056)
14	Action on request from Bear Development for a release from Developer's Agreement between Somers for the former Willow Creek Condominium project (Parcels 82-4-222-151-0560, 82-4-222-151-0561, 82-4-222-151-0563)
15	Action on application for Class "B" (Picnic) Beer License from Shoreland Lutheran High School Booster Club for the Connections We Make: Dinner & Auction Event on April 5, 2025. Event to be held at Shoreland Lutheran High School, 9026 12th Street Kenosha, WI 53144
16	Action on application for Temporary Operators License: Amber Wasurick, for the Shoreland Lutheran High School Shoreland Lutheran High School Booster Club for the Connections We Make: Dinner & Auction Event and request to waive fee
17	Action on application for Special Event Permit from Elisabeth Pearson – Wedding/Reception, at the Girl Scouts of Wisconsin site located at 3901 1st St. Kenosha, WI 53144
18	Action on proposed Resolution No. 2025-004, A Resolution Authorizing Submittal of MS4 Report
19	Action on Operator's Licenses: Coleton Hanna and William Valencia
20	Adjourn

I hereby certify that as the designee of the chief elected official of the Village of Somers, I posted this notice of the March 11th, 2025 Village Board Meeting & Agenda in 1 public place & on the Village website.

Dated this 7th day of March 2025

Wendy Burnette, Clerk-Treasurer

Requests from person with disabilities who need assistance to participate in this meeting should be made to the Clerk's Office at 262-859-2822 with as much notice as possible. **Notice is hereby given that members of the Village Board may participate telephonically. Notice is hereby given that members of the Town Board may be in attendance for the sole purpose of gathering information. A quorum may be present. However, no Board action will be taken.**

**Village of Somers
Proceedings from the Regular Board Meeting February 25, 2025**

President Stoner called the meeting to order at 5:30 p.m.

President Stoner led the Pledge of Allegiance.

Present: President George Stoner, Trustees Karl Ostby, Ben Harbach, Scott Fredrick, Jack Aupperle, Jackie Nelson, and Joe Smith. Also present: Administrator Jason Peters, Clerk/Treasurer Wendy Burnette, Eugenia Lara Deputy Clerk, Assistant to the Administrator Kevin Poirier, and Attorney Jeff Davison.

Consent and Approval of Minutes of Regular meetings on February 11, 2025, Vouchers dated February 13, 2025, February 20, 2025, and December 2024 Investment Report

Trustee Nelson moved to approve Minutes of Regular meetings on February 11, 2025. Vouchers dated February 13, 2025, February 20, 2025, and December 2024 Investment Report.

Seconded by Trustee Aupperle.

Motion carried 7-0 vote.

Correspondence:

- a. Mount Pleasant Notice of amendment to Multi-Jurisdictional Comprehensive Plan for 2035

Citizens Comments

Randall Hansen 1105 65th St Kenosha, WI – He mentioned he has lived in the Village for 26 years and the snow removal has been outstanding the last 3 years.

Paul Scriver 9026 12th St Kenosha, WI –Shoreland High School project wanted to thank the Village for the efforts in investigating and making an informed decision on the water main as it relates to the Shoreland project. Mr. Scriver had a few questions. Should Shoreland be considered a development with a 31,000 sq ft add on to an 84,000 sq ft building. Is it legitimately conclusive or legal that Shoreland be required to foot bill for the project with potential full reimbursement. In previous meetings, there was concern about the student's safety and water capacity if a fire broke out in the school. Mr. Scriver mentioned that he spoke to his engineers, and they determined that the school would have enough water to sprinkle 60 minutes. Mr. Scriver also mentioned that in a memo by the Kenosha Water Utility that Shoreland did not have to hook up to water. He is hoping to continue to move forward with this project as they are on track for another record enrollment for the 2025-2026 school year.

President and Trustee Comments:

Trustee Nelson asked Mr. Scriver if he could forward the letter from Kenosha Water Utility to Administrator Peters regarding the main water hook up.

Action on proposed Resolution 2025-003, a Resolution to amend the 2025 Budget to reference updated Capital Improvement Plan projects for 2025 (Storm Water – Neumiller Phase II allocation to the Gitzlaff Phase II allocation)

Trustee Aupperle moved to approve the Resolution 2025-003, a Resolution to amend the 2025 Budget to reference updated Capital Improvement Plan Projects for 2025 (Storm Water-Neumiller Phase II allocation to the Gitzlaff Phase II allocation)

Seconded by Trustee Ostby.

Trustee Harbach asked if the project for Somers is \$39,801.00 and Administrator Peters confirmed and stated the Village portion of it would be \$8,000.

Motion carried. 7-0 vote.

Discussion and possible action on Change Order #1 from Payne and Dolan in the amount of \$9,160.50 for the intersection of the Multi-Use Trail and 13th Avenue, a part of the 2024 Roadway Improvements Program (13th Avenue and 16th Place).

Trustee Aupperle moved to approve Change Order #1 from Payne and Dolan in the amount of \$9,160.50 for the intersection of Multi-Use Trail and 13th Avenue, a part of the 2024 Roadway Improvements Program (13th Avenue and 16th Place).

Seconded by Trustee Smith.

Motion carried. 7-0 vote.

Discussion and possible action on request for partial payment #1 from Payne and Dolan in the amount of \$458,611.32 for the 2024 Roadway Improvements Program (13th Avenue and 16th Place).

Trustee Aupperle moved to approve the action request of partial payment#1 from Payne and Dolan in the amount of \$458,611.32 for the 2024 Roadway Improvements Program (13th Avenue and 16th Place).

Seconded by Trustee Ostby

Trustee Harbach asked the Village engineer if everything is good. The change order was to realign the trailer and a curb by Kenosha Country Club.

Motion carried. 7-0 vote.

Approval of Operator’s Licenses: Callie Adams and Joshua Reed

Trustee Harbach moved to approve Operator Licenses: Callie Adams and Joshua Reed.

Seconded by Trustee: Smith.

Motion carried. 7-0 vote.

Trustee Ostby asked Clerk Burnette to introduce her new Deputy Clerk/Treasurer, Eugenia Lara. Deputy Clerk Lara started with the Village on February 3, 2025.

Adjourn

Trustee Harbach moved to adjourn the meeting at 5:40pm.

Seconded by Trustee Aupperle.

Motion carried. 7-0 vote.

Drafted this 3rd day of March by Wendy Burnette Clerk/Treasurer

These minutes are not official until approved by the Village Board.

Check Date	Bank	Check	Vendor	Vendor Name	Amount
Bank POOL POOLED CASH					
02/27/2025	POOL	247 (E)	KWIKTRIP	KWIK TRIP INC	5,329.22
02/27/2025	POOL	64493	AED	AED ESSENTIALS INC	2,006.79
02/27/2025	POOL	64494	ALLHANDS	ALL HANDS FIRE EQUIPMENT LLC	2,413.00
02/27/2025	POOL	64495	AAC001	ASSOCIATED APPRAISAL	4,967.99
02/27/2025	POOL	64496	BAXTER	BAXTER & WOODMAN	11,843.40
02/27/2025	POOL	64497	BLAINFF	BLAIN SUPPLY INC	667.34
02/27/2025	POOL	64498	BTM001	BOUND TREE MEDICAL LLC	321.95
02/27/2025	POOL	64499	SPECTRUM	CHARTER COMMUNICATIONS	183.33
02/27/2025	POOL	64500	CLEARCOM	CLEARCOM INCORPORATED	255.00
02/27/2025	POOL	64501	DAV001	DAVISON LAW OFFICE, LTD	8,008.00
02/27/2025	POOL	64502	EMC	EMC INSURANCE COMPANIES	842.10
02/27/2025	POOL	64503	FAIRWINDS	FAIRWINDS CANVAS LLC	1,325.00
02/27/2025	POOL	64504	JEF001	JEFFERSON FIRE & SAFETY INC	326.56
02/27/2025	POOL	64505	JWM001	JERRY WILLKOMM INC	339.30
02/27/2025	POOL	64506	KWU002	KENOSHA WATER UTILITY	67,468.73
02/27/2025	POOL	64507	MCDEVITTS	MCDEVITTS TOWING & REPAIR	1,139.00
02/27/2025	POOL	64508	MTP001	MT PLEASANT SEWER UTILITY	37,845.00
02/27/2025	POOL	64509	NAP001	NAPA AUTO PARTS	166.50
02/27/2025	POOL	64510	PAY001	PAYNE & DOLAN INC	458,611.32
02/27/2025	POOL	64511	SOUTHPORT	SOUTHPORT ENGINEERED SYSTEMS	631.95
02/27/2025	POOL	64512	STRY001	STRYKER SALES LLC	3,095.46
02/27/2025	POOL	64513	THELETTER	THE LETTERING MACHINE	731.25
02/27/2025	POOL	64514	WEE001	WE ENERGIES	67.74
02/27/2025	POOL	64515	WELDSTAR	WELDSTAR COMPANY	516.46
02/27/2025	POOL	64516	WSC001	WISCONSIN SUPREME COURT	800.00

POOL TOTALS:

Total of 25 Checks:	609,902.39
Less 0 Void Checks:	0.00
Total of 25 Disbursements:	<u>609,902.39</u>

Check Date	Bank	Check	Vendor	Vendor Name	Amount
Bank POOL POOLED CASH					
03/06/2025	POOL	248 (E)	VERIZON	VERIZON WIRELESS	360.01
03/06/2025	POOL	64520	AED	AED ESSENTIALS INC	820.00
03/06/2025	POOL	64521	AMEROUTFIT	AMERICAN OUTFITTERS LTD	1,768.90
03/06/2025	POOL	64522	AMERICANPR	AMERICAN PRINTING TECHNOLOGIES INC	1,281.09
03/06/2025	POOL	64523	BRUM	ANN BRUMBACK	64.01
03/06/2025	POOL	64524	AT&TMOB	AT&T MOBILITY	483.95
03/06/2025	POOL	64525	ANDERSEN	BEN ANDERSEN	60.17
03/06/2025	POOL	64526	BLAINFF	BLAIN SUPPLY INC	1,495.81
03/06/2025	POOL	64527	SPECTRUM	CHARTER COMMUNICATIONS	32.88
03/06/2025	POOL	64528	CORE	CORE & MAIN LP	303.12
03/06/2025	POOL	64529	CUMMINS	CUMMINS SALES & SERVICE	1,983.78
03/06/2025	POOL	64530	TRI-VISA	ELAN FINANCIAL SERVICES	4,745.95
03/06/2025	POOL	64531	FLOCK	FLOCK GROUP INC	18,250.00
03/06/2025	POOL	64532	STO001	GEORGE STONER	211.60
03/06/2025	POOL	64533	PETERS	JASON PETERS	300.00
03/06/2025	POOL	64534	JEF001	JEFFERSON FIRE & SAFETY INC	1,920.54
03/06/2025	POOL	64535	SOR001	JOHN E SORENSEN	85.29
03/06/2025	POOL	64536	JOHNS	JOHNS DISPOSAL SERVICE INC	49,219.75
03/06/2025	POOL	64537	KCSHERIF	KENOSHA CO SHERIFF DEPT	71,531.24
03/06/2025	POOL	64538	KEN002	KENOSHA COUNTY TREASURER	2,355.40
03/06/2025	POOL	64539	KWU002	KENOSHA WATER UTILITY	42.00
03/06/2025	POOL	64540	LAWEVANS	LAW OFFICE OF TIMOTHY R EVANS	4,175.00
03/06/2025	POOL	64541	LIFEASSIST	LIFE-ASSIST INC	165.36
03/06/2025	POOL	64542	MINUTEMAN	MINUTEMAN PRESS KENOSHA	205.84
03/06/2025	POOL	64543	PAL001	PALMEN	467.10
03/06/2025	POOL	64544	STERICYCLE	STERICYCLE INC	17.65
03/06/2025	POOL	64545	T0000175	STEVEN KRAUSE	228.97
03/06/2025	POOL	64546	PEREZT	TERESA PEREZ	400.00
03/06/2025	POOL	64547	THOMASOUT	THOMAS OUTDOOR SUPPLY	180.12
03/06/2025	POOL	64548	USPOST	US POSTMASTER	434.57
03/06/2025	POOL	64549	WEE001	WE ENERGIES	240.45
03/06/2025	POOL	64550	WEE002	WE ENERGIES	87.02
03/06/2025	POOL	64551	WBURNETTE	WENDY BURNETTE	150.00
03/06/2025	POOL	64552	WICOURT	WI COURT FINES & SURCHARGES	8,001.04
03/06/2025	POOL	64553	WAM001	WILLIAM A MORRIS	149.42

POOL TOTALS:

Total of 35 Checks:

172,218.03

Less 0 Void Checks:

0.00

Total of 35 Disbursements:

172,218.03



BUILDING REPORT - January, 2025

FUND CODE & DESCRIPTION	NUMBER OF PERMITS	PERMIT FEES MONTHLY	NUMBER OF PERMITS YEAR TO DATE	PERMIT FEES YEAR TO DATE	DIFFERENCE FROM 2024 TO 2025
101-HOUSES	1	1,963.71	1	1,963.71	(2,371.49)
101-ADDITIONS & ALTERATIONS-RES	5	325.00	5	325.00	(300.65)
101-ACCSRY BLD	2	513.95	2	513.95	(1,421.65)
101-NEW MOBILE HM	0	0.00	0	0.00	0.00
101-OTHER PMT FEE	0	0.00	0	0.00	(650.00)
101-AGRICULTURAL	0	0.00	0	0.00	(843.00)
101-APARTMENTS-MLF	0	0.00	0	0.00	0.00
101-CONDOMINIUM	0	0.00	0	0.00	0.00
101-COMMERCIAL BLD	0	0.00	0	0.00	0.00
101-INDUSTRIAL (COMM)	0	0.00	0	0.00	0.00
101-ADDITIONS & ALTERATIONS-COMM	0	0.00	0	0.00	(22,831.00)
101-SIGNS	0	0.00	0	0.00	(85.00)
101-PLUMBING	2	395.00	2	395.00	(8,513.00)
101-HEATING	3	195.00	3	195.00	(3,489.02)
101-ELECTRIC	4	505.00	4	505.00	(22,953.55)
101-POOLS	0	0.00	0	0.00	(2,010.00)
101-WRECKING	0	0.00	0	0.00	(2,199.32)
101-OCCUPANCY	0	0.00	0	0.00	(500.00)
101-FENCE	1	130.00	1	130.00	(195.00)
101-DRIVEWAY	0	0.00	0	0.00	(130.00)
101-CULVERT	0	0.00	0	0.00	0.00
101-DUMPSTER	3	75.00	3	75.00	75.00
101-RIGHT OF WAY ROAD OPENING	1	100.00	1	100.00	(900.00)
101-EROSION CONTROL	0	0.00	0	0.00	0.00
101-VOLUNTARY DONATION IN LIEU OF IMPACT FEES	0	0.00	0	0.00	(4,590.00)
101-LANDFILL PMT	1	265.00	1	265.00	200.00
101-PUBLIC WKS	0	0.00	0	0.00	0.00
101-PARK FEE	0	0.00	0	0.00	0.00
101-FIRE STATION	0	0.00	0	0.00	0.00
101-WA MTR HORN	1	245.00	1	245.00	245.00
101-WA PMT	0	0.00	0	0.00	0.00
101-REFUND PERMIT	0	0.00	0	0.00	0.00
SUB-TOTAL 101	24	4,712.66	24	4,712.66	(73,462.68)
603-UD SR SVC FEE	1	2,800.00	1	2,800.00	0.00
603-	0	0.00	0	0.00	0.00
SUB-TOTAL 603	1	2800.00	1	2800.00	0.00
602-KR SR SVC FEE	0	0.00	0	0.00	0.00
SUB-TOTAL 602	0	0.00	0	0.00	0.00
601-WA FEE	0	0.00	0	0.00	(2,700.00)
601-TEMP WA FEE	0	0.00	0	0.00	(299.64)
601-WA MTR HORN	0	0.00	0	0.00	(41,565.11)
601-WA PMT	0	0.00	0	0.00	0.00
601-	0	0.00	0	0.00	0.00
601-	0	0.00	0	0.00	0.00
SUB-TOTAL 601	0	0.00	0	0.00	(44,564.75)
TOTALS	25	7,512.66	25	7,512.66	(118,027.43)



BUILDING REPORT - February, 2025

FUND CODE & DESCRIPTION	NUMBER OF PERMITS	PERMIT FEES MONTHLY	NUMBER OF PERMITS YEAR TO DATE	PERMIT FEES YEAR TO DATE	DIFFERENCE FROM 2024 TO 2025
101-HOUSES			1	1,963.71	(2,371.49)
101-ADDITIONS & ALTERATIONS-RES	5	1,367.40	10	1,692.40	1,066.75
101-ACCSRY BLD	2	785.00	4	1,298.95	(636.65)
101-NEW MOBILE HM			0	0.00	0.00
101-OTHER PMT FEE			0	0.00	(650.00)
101-AGRICULTURAL			0	0.00	(843.00)
101-APARTMENTS-MLF			0	0.00	0.00
101-CONDOMINIUM			0	0.00	0.00
101-COMMERCIAL BLD	1	300.00	1	300.00	300.00
101-INDUSTRIAL (COMM)			0	0.00	0.00
101-ADDITIONS & ALTERATIONS-COMM			0	0.00	(22,831.00)
101-SIGNS			0	0.00	(85.00)
101-PLUMBING	3	361.50	5	756.50	(8,151.50)
101-HEATING	3	195.00	6	390.00	(3,294.02)
101-ELECTRIC	5	850.00	9	1,355.00	(22,103.55)
101-POOLS			0	0.00	(2,010.00)
101-WRECKING	1	65.00	1	65.00	(2,134.32)
101-OCCUPANCY			0	0.00	(500.00)
101-FENCE	1	65.00	2	195.00	(130.00)
101-DRIVEWAY			0	0.00	(130.00)
101-CULVERT			0	0.00	0.00
101-DUMPSTER			3	75.00	75.00
101-RIGHT OF WAY ROAD OPENING	2	200.00	3	300.00	(700.00)
101-EROSION CONTROL			0	0.00	0.00
101-VOLUNTARY DONATION IN LIEU OF IMPACT FEES			0	0.00	(4,590.00)
101-LANDFILL PMT			1	265.00	200.00
101-PUBLIC WKS			0	0.00	0.00
101-PARK FEE			0	0.00	0.00
101-FIRE STATION			0	0.00	0.00
101-WA MTR HORN			1	245.00	245.00
101-WA PMT			0	0.00	0.00
101-REFUND PERMIT			0	0.00	0.00
SUB-TOTAL 101	23	4,188.90	47	8,901.56	(69,273.78)
603-UD SR SVC FEE			1	2,800.00	0.00
603-			0	0.00	0.00
SUB-TOTAL 603			1	2800.00	0.00
602-KR SR SVC FEE			0	0.00	0.00
SUB-TOTAL 602			0	0.00	0.00
601-WA FEE			0	0.00	(2,700.00)
601-TEMP WA FEE			0	0.00	(299.64)
601-WA MTR HORN			0	0.00	(41,565.11)
601-WA PMT			0	0.00	0.00
601-			0	0.00	0.00
601-			0	0.00	0.00
SUB-TOTAL 601			0	0.00	(44,564.75)
TOTALS	23	4,188.90	48	11,701.56	(113,838.53)

**VILLAGE OF SOMERS
VILLAGE BOARD
MEETING ITEM MEMORANDUM**

MEETING DATE: March 11th, 2025

TO: Village President Stoner and Village Trustees

PREPARED BY: Jason J. Peters, Administrator

AGENDA ITEM: #7 Action on whether to direct staff and Attorney Davison to include the installation of the proposed water main for Shoreland Lutheran High School Federation Development Agreement for proposed project on Parcel # 82-4-222-084-0272

BACKGROUND:

In April of 2024, the Board approved a Comp Plan Change, Rezoning and CSM so that Shoreland Lutheran High School could install a stormwater management system. The proposed system is known as a Regenerative Stormwater Conveyance. This system was in preparation for any expansions to their facilities. In August of 2024, Staff met with Shoreland Lutheran to review the proposed additions to their existing buildings. The proposed additions will include the following: an expanded music room, eight new classrooms, a new main entry/vestibule area, a new fitness center, and a new gymnasium. The existing gymnasium will also be remodeled as a part of the plan. The project requires a conditional use permit for the new gymnasium and site plan/exterior fenestration. Shoreland Lutheran submitted their applications at the end of August. The Board conditionally approve the CUP, site plan and exterior fenestration in November of 2024. This allowed Shoreland to move forward with their final plans for their project.

The Board may recall that in 2021, Mastercraft proposed a subdivision across the street from this site. At that time the estimate for the total cost of bring water main from 100th Avenue was \$807,000. As this estimate is several years old, Engineering has provided an updated opinion of probable cost. This new cost is approximately \$1.5 million and includes running the line to the corner of CTH E and CTH H. Baxter Woodman has provided an updated draft Schedule to show the assessments would be, if this water main were to be constructed and assessments were levied.

Memorandums from Attorney Davison, Chief Andersen and KWU as their opinions on the requirement that municipal water be extended for this project have been included in past packages and are attached. Chief Andersen has supplemented his opinion on the matter to the Board through an email dated 2/24/2025 and is also included. At our

February 4th Work Session, it was requested that Staff reach out the PSC to get their input on the matter. Attorney Davison has spoken to PSC Counsel, and they have indicated that whether or not this water main extension happens is up to the Village.

The question of what is considered a development has been a topic of conversation. While the Village's General Code of Ordinances does give a definition of a development, the Village's Zoning Code does. Under Chapter ZN A Appendix a – Definitions defines Development as follows:

DEVELOPMENT

Any artificial change to improved or unimproved real estate, including, but not limited to, the construction of buildings, structures or accessory structures; *the construction of additions or alterations to buildings, structures or accessory structures*; the repair of any damaged structure or the improvement or renovation of any structure, regardless of percentage of damage or improvement; the placement of buildings or structures; subdivision layout and site preparation; mining, dredging, filling, grading, paving, excavation or drilling operations; the storage, deposition or extraction of materials or equipment; and the installation, repair or removal of public or private sewage disposal systems or water supply facilities. (*emphasis added*).

The current project would fall under the Zoning Code's definition of a development.

PRIOR ACTION TAKEN:

One of the requirements for the project to move forward is the execution of a developer's agreement. At our March 4th Work Session, the Board further discussed whether the water main will be a requirement in the development agreement. The general consensus was that the installation of the water main should be a requirement in the development agreement. The Board directed Staff to bring this question to the Board for formal action.

SUGGESTED ACTION/ACTION REQUESTED/COMMENTS:

Staff is now bringing forth the question of whether the water main will be a requirement in Shoreland's proposed development agreement. If the water is to be a requirement, the Board will need to further explore how the project costs would be paid. If the Village were to bring this water main down, it would have to be through the issuance of bond. Staff has also explored the option of self-funding the project through a loan from the sewer fund. This option would eliminate borrowing costs (bond counsel, etc.) and allow greater latitude on interest rates and payment schedules. Administrator Peters has created an amortization schedule for the entire project and each affected parcel.

Another option would be to have the developer "upfront" the costs. Shoreland has indicated that this is not a feasible option for them.

Administration has also explored the option of extending a TID #6 or using the ½ mile rule for utility extensions to help pay for the project. Extending TID #6 Borders is not

feasible. Administration does believe that using the ½ mile rule for utility extension is a viable option as we do not foresee enough development in TID #6 to create enough increment to pay for additional utilities.

If the Board, moves forward with the main, then further work sessions will need to be held to discuss with the affected parcels and Shoreland on how this project will be funded. The amortization schedules can/will be made available to the Board and affected parcels. In the event that the Village Board wishes to direct staff to include the water main as requirement, a suggested motion to approve would be as follows:

“Motion to direct staff and Attorney Davison to include the installation of the proposed water main for Shoreland Lutheran High School Federation Development Agreement for proposed project on Parcel # 82-4-222-084-0272”

ATTACHMENTS:

Draft Assessment Schedule

Correspondence from KWU

Memorandum from Attorney Davison

Memorandum from Chief Andersen

Email from Chief Andersen

SCHEDULE C

DRAFT

ASSESSMENT SCHEDULE
 Shoreland Lutheran - Water Main Extension
 Village of Somers

OWNER	TAX KEY NO.	ADDRESS	WATER MAIN	
			FRONTAGE (FEET)	ASSESSMENT
			Assessment Per Foot \$204.24	
Somers United Church of Christ	82-4-222-083-0111	9918 12th Street	346.00	\$ 70,668.67
Paul Gitzlaff	82-4-222-083-0115	12th Street	264.00	\$ 53,920.60
Paul Gitzlaff	82-4-222-083-0125	12th Street	112.00	\$ 22,875.41
Thaddeus G. Demicchi	82-4-222-083-0120	9700 12th Street	112.00	\$ 22,875.41
Matthew Mathey	82-4-222-083-0130	9610 12th Street	112.00	\$ 22,875.41
Shoreland Lutheran High School	82-4-222-084-0301	9026 12th Street	1324.88	\$ 270,599.73
Tammy Rose	82-4-222-084-0425	9230 12th Street	212.30	\$ 43,361.15
Matthew J. Mitten	82-4-222-084-0406	9210 12th Street	245.98	\$ 50,240.11
Jeanne Haverkamp	82-4-222-084-0415	9130 12th Street	120.00	\$ 24,509.37
Richard Vanderleest	82-4-222-084-0420	9122 12th Street	120.00	\$ 24,509.37
Richard Vanderleest	82-4-222-084-0265	9110 12th Street	124.00	\$ 25,326.34
Thomas J. Harper	82-4-222-084-0280	8910 12th Street	141.50	\$ 28,900.63
Leroy M. and Myrtle J. Johnson Revocable Trust	82-4-222-084-0285	8830 12th Street	141.50	\$ 28,900.63
BMM Properties, LLC	82-4-222-084-0291	8820 12th Street	123.30	\$ 25,183.37
Benjamin Metz	82-4-222-084-0296	8810 12th Street	140.00	\$ 28,594.26
David Van Blarcom	82-4-222-172-0180	9915 12th Street	100.00	\$ 20,424.47
Jason E. Christensen	82-4-222-172-0170	9905 12th Street	174.25	\$ 35,589.64
George L. Mikulski	82-4-222-172-0160	9821 12th Street	295.75	\$ 60,405.37
Michael Guenter Boozer	82-4-222-172-0150	9725 12th Street	244.00	\$ 49,835.71
Steven G. Raith	82-4-222-172-0145	1212 97th Avenue	125.00	\$ 25,530.59
Carol A. Anderson	82-4-222-172-0010	1209 97th Avenue	125.00	\$ 25,530.59
Anthony D. Looney	82-4-222-172-0005	9601 12th Street	100.00	\$ 20,424.47
James Clark	82-4-222-171-0540	9415 12th Street	297.00	\$ 60,660.68
Wendy S. Denman	82-4-222-171-0535	9407 12th Street	162.55	\$ 33,199.98
Janal Family Trust	82-4-222-171-0530	1208 93rd Avenue	142.00	\$ 29,002.75
Lori J. Scharneck	82-4-222-171-0115	9221 12th Street	142.00	\$ 29,002.75
Tehl Borger	82-4-222-171-0111	9219 12th Street	40.00	\$ 8,169.79
Tehl Borger	82-4-222-171-0101	9211 12th Street	125.00	\$ 25,530.59
Mastercraft Builders, LLC	82-4-222-171-0043	12th Street	338.00	\$ 69,034.71
Mastercraft Builders, LLC	82-4-222-171-0041	9193 12th Street	100.00	\$ 20,424.47
Mastercraft Builders, LLC	82-4-222-171-0042	12th Street	100.00	\$ 20,424.47
Michael A. Andresen	82-4-222-171-0031	9025 12th Street	143.93	\$ 29,396.94
Ted Terletzky	82-4-222-171-0035	9015 12th Street	150.00	\$ 30,636.71
Merwyn N. Tetzlaff	82-4-222-171-0025	9001 12th Street	540.18	\$ 110,328.91
SAMC Enterprise, LLC	82-4-222-171-0010	88th Avenue	241.70	\$ 49,365.95
TOTALS			7325.82	\$ 1,496,260.00

Board of Water Commissioners

Dominic Ruffalo, Chairperson
Anthony Kennedy, Vice Chairperson
Brandi Ferree
Peni Keeling
Jack Rose
Bill Siel



Curtis Czarnecki
General Manager

4401 Green Bay Road
Kenosha, WI 53144
Phone (262) 653-4306
Fax (262) 653-4303

"Providing and Protecting Kenosha's Greatest Natural Resource"

November 14, 2024

To: Jason Peters, Village Administrator
From: Curt Czarnecki, General Manager
Subject: Shoreland Lutheran High School Proposed Addition

The Village of Somers contacted the Kenosha Water Utility regarding an addition to the Shoreland Lutheran High School campus. Village representatives indicated a condition of the approval was to extend municipal water service to the property in question and require the campus to connect to municipal sanitary sewer and water service. The Village requested the Kenosha Water Utility to review this development for compliance with the intergovernmental agreements in place.

After reviewing the intergovernmental agreement, it appears the requirement to extend municipal water service and connect the campus to municipal sanitary sewer and water does not conflict with the agreement provided the municipal sanitary sewer and water service is provided by the Kenosha Water Utility and not an alternative source. The Kenosha Water Utility has no objections to the conditions of approval for this proposed development.

Please contact me should you have any questions or concerns.

Sincerely,

A handwritten signature in black ink that reads "Curt Czarnecki".

Curtis Czarnecki

Attorney Jeffrey J. Davison

1207 55th Street
Kenosha, WI 53140
Telephone No. (262) 657-5165
Fax No. (262) 657-5517
dmltd@sbcglobal.net

Memorandum

TO: Jason Peters
FROM: Jeffrey J. Davison
CC: George Stoner, Jack Aupperle, Karl Ostby, Scott Fredrick, Joe Smith, Jackie Nelson, Ben Harbach
DATE: November 14, 2024
SUBJECT: Proposed Municipal Water for Shoreland Lutheran High School

You have requested that I provide to you a memo concerning the legal issues surrounding the extension of municipal water to the above proposed project. This memo will focus on the regulatory and contractual requirements which the Village must follow. Somers requires by ordinance that a developer bring municipal services to a proposed development. The potential inequality of hypothetical special assessments to benefitted property owners who do not seek municipal water and where the benefit may be outweighed by the cost, the pitfalls of attempting to service individual homes on individual private wells which would have to be abandoned as well as related topics as they all have been discussed by the Village Board. For purposes of the following discussion, I will assume that the Village is not interested in borrowing to enable the water main to be extended to the subject site based upon the comments of the Board and, of course, it is quite obvious that the Water Utility itself is not in a position to fund such an extension.

The first matter to be considered is the regulatory framework which the Public Service Commission (PSC) has put in place for the Water Utility's operations and specifically, for service and extensions. The Water Utility is required to enforce hookups to parcels where municipal water becomes available. Obviously, this is not only a health and safety requirement, it is important for the financial success of the Water Utility by acquiring new customers. As the subject site is not currently contiguous to a municipal water main, the standard which is imposed by the PSC, so the next relevant inquiry is what the

PSC requires with regard to water main extensions.

These requirements are contained in the PSC rate tariffs for the Village of Somers Water Utility and specifically in Amendment No. 13 Schedule No. X-2 and Schedule No. X-3, copies of which I have attached. As you can see from the water main extension rule, where the Village is unwilling or unable to fund the cost for the extension, it . . . “will be made on a customer-financed (i.e. developer) basis. . .” Developer must advance as the contribution for construction the total amount which would have been assessed for all benefitted property owners. In other words, the total project cost. The rule goes on to say that a portion of the contribution made by the developer will be refundable “when additional customers are connected to the extended main within 10 years of the date of completion . . .” Stated differently, this rule is not even as favorable to a developer as the cost recovery incentives which we have provided in Development Agreements to other developers and which we offered to this developer since it requires a connection which must be made within 10 years or forfeited.

Schedule No. X-3, Water Main Installation in Platted Subdivisions, requires that the developer shall be responsible for the total costs of construction in platted subdivisions whether the developer contracts for the construction or it is installed by the Village Utility. Given the recent historical issues which the Village Water Utility has had with PSC staff, my opinion would be that it is imperative that the Village insist that the extension of water mains to and within the subdivision be entirely developer funded if the Village is not willing to issue general obligation debt to construct the improvements. Although the PSC rules does not explicitly prohibit the installation of private wells in a platted subdivision, that concept would certainly seem to be contrary to the intent of the rules and the PSC staff interpretation may very well be that the Somers tariff requires installation of municipal water in platted subdivisions.

Next, I reviewed the contractual obligations between the Village and the Kenosha Water Utility/City of Kenosha under the various boundary and utility service agreements between those entities. Specifically, the City of Kenosha/Town of Somers Cooperative Plan under Section 66.0307, Wis. Stats. (the 2005 Boundary Agreement) and the accompanying 2005 Intergovernmental Agreement for orderly development by and between the City of Kenosha and Kenosha Water Utility, and Town of Somers Somers Water Utility and Somers Sewer Utility District (the 2005 Utility Agreement) as well as the 2017 City of Kenosha/Village of Somers/Town of Somers/Town of Paris/County of Kenosha/Kenosha Water Utility/Village of Somers Water Utility/Village of Somers Sewerage District/County Highway Commissioner Cooperative Plan and Intergovernmental Agreement under Sections 66.0301, 66.0305 and 66.0307, Wis. Stats. (the Comprehensive Boundary Agreement). The 2017 Comprehensive Boundary

Agreement creates an obligation for the Village to become the successor in interest to both the 2005 Boundary Agreement and the 2005 Utility Agreement (since the Village was incorporated after those dates) and is replete with references concerning the orderly planning for land development including the extension of municipal utilities.

The 2005 Boundary Agreement discusses the orderly development of utilities and provision of municipal water and sewer to the then-Town under the terms of the 2005 Utility Agreement. The 2005 Utility Agreement, among other things, provides that the Kenosha Water Utility shall provide municipal water service in the “potential Town service area” and that all plans and specifications for water distribution facilities must be reviewed and approved by the Kenosha Water Utility. The site of the proposed development is within the “potential Town service area” as depicted on the exhibits to the Agreement. The Agreement also provides that the Town (now Village) Water Utility adopt and be bound by all of the rules and regulations of the Kenosha Water Utility, which are extensive and are contained in Chapter 32 of the City of Kenosha Code of Ordinances entitled “Kenosha Water Utility Water and Sewerage Systems”. These ordinances adopt verbatim the PSC municipal water extension rules and platted subdivision rules.

Shoreland Lutheran High School has made this request in order to expand their facility.

Finally, the then-Town and now Village of Somers adopted Sections 13.48 and 13.49 of the Code of Ordinances requiring all new construction situated within the Water Utility District and in which the extension of public water may be deemed feasible be connected to the public water supply and requiring that municipal water be constructed for all new subdivisions. Based upon all of the foregoing, it would be my opinion that the regulatory requirements of the PSC, the contractual obligations between the Village and the City of Kenosha and the Village’s own ordinances would prohibit the installation of private wells in this development and would require the developer fund main extensions to the extent that the Village chooses not to fund such a project.

I am hopeful that the foregoing has been responsive to your inquiry. Should you have any questions, please do not hesitate to contact me.

RATE FILE

Sheet No. 1 of 1

Public Service Commission of Wisconsin

Schedule No. X-2

Village of Somers Water Utility

Amendment No. 13

Water Main Extension Rule

Water mains will be extended for new customers on the following basis:

- A. Where the cost of the extension is to immediately be collected through assessment by the municipality against the abutting property, the procedure set forth under Wis. Stat. § 66.0703 will apply, and no additional customer contribution to the utility will be required.
- B. Where the municipality is unwilling or unable to make a special assessment, the extension will be made on a customer-financed basis as follows:
 - 1. The applicant(s) will advance as a contribution in aid of construction the total amount equivalent to that which would have been assessed for all property under paragraph A.
 - 2. Part of the contribution required in paragraph B.1. will be refundable. When additional customers are connected to the extended main within 10 years of the date of completion, contributions in aid of construction will be collected equal to the amount which would have been assessed under paragraph A. for the abutting property being served. This amount will be refunded to the original contributor(s). In no case will the contributions received from additional customers exceed the proportionate amount which would have been required under paragraph A., nor will it exceed the total assessable cost of the original extension.
- C. When a customer connects to a transmission main or connecting loop installed at utility expense within 10 years of the date of completion, there will be a contribution required of an amount equivalent to that which would have been assessed under paragraph A.

EFFECTIVE: October 20, 2017
PSCW AUTHORIZATION: 5545-TW-100

RATE FILE

Sheet No. 1 of 1

Public Service Commission of Wisconsin

Schedule No. X-3

Village of Somers Water Utility

Amendment No. 13

Water Main Installations in Platted Subdivisions

Application for installation of water mains in regularly platted real estate development subdivisions shall be filed with the utility.

If the developer, or a contractor employed by the developer, is to install the water mains (with the approval of the utility), the developer shall be responsible for the total cost of construction.

If the utility or its contractor is to install the water mains, the developer shall be required to advance to the utility, prior to the beginning of the construction, the total estimated cost of the extension. If the final costs exceed estimated costs, an additional billing will be made for the balance of the cost due. This balance is to be paid within 30 days. If final costs are less than estimated, a refund of the overpayment will be made by the water utility.

EFFECTIVE: October 20, 2017
PSCW AUTHORIZATION: 5545-TW-100

SOMERS FIRE & RESCUE

P.O. Box 197
Somers, WI 53171
(262-859-2277)



CHIEF
Benjamin Andersen

To: Village Board

Regarding: Shoreland Lutheran High School and municipal water

I Chief Andersen feel like there has been some misleading or misunderstood information floating around about what I have said about Shoreland Lutheran High School, municipal water and how it relates to their fire protection system. Below are my statements as it pertains to their water required for their fire protection system.

- For their addition Shoreland will have to submit plans to the state for their expansion of the buildings fire protection system.
 - The state will determine if the current well, tank, and pump system is capable of supplying the expanded system.
 - If the state deems the current system adequate, I have no authority to make them change anything including bringing water main to the site.
 - If the state deems the current system is not adequate, then Shoreland will have to create a system that will supply adequate water.
 - This could be done though a combination of things such as a larger well, larger storage tanks or other changes to the system onsite.
 - Or the option of connecting to municipal water.
- It was recently stated that Per NFPA 1 national fire code that a fire chief can make a property owner bring municipal water to a site. I do not believe this to be correct. In all of the research I have been able to do, a fire chief cannot make someone bring water to a site, however a fire chief can require that they connect once water is brought to the site. The code states that a water supply source capable of supplying the required fire flow shall be provided. The required fire flow and supply source capabilities is what the state plan review system will check. So, if they choose not to bring water now and it is brought to the site at a later date our Village of Somers Ordinance 16.28 requires, they connect the buildings fire protection system to the municipal water within 6 months. Ordinance shown below.
 - *§ 16.28NON-HYDRANTS AREAS.*
 - (A)
 - *Any building which is subject to the requirements of this chapter pertaining to automatic fire sprinkler systems or an automatic fire suppression system and which is located in a non-hydrant area of the Village of Somers (an area without public water mains), shall be provided with an approved source of water supply capable of providing a maximum pressure of 50 psi to the building's automatic fire sprinkler system(s) and/or automatic fire suppression system(s).*
 - (B)
 - *Should a public water main be installed at the site of an existing building which is protected by either an existing automatic fire sprinkler system or an existing automatic fire suppression*

SOMERS FIRE & RESCUE

P.O. Box 197
Somers, WI 53171
(262-859-2277)



CHIEF
Benjamin Andersen

system, the owner shall connect the existing system(s) to the public water main within six months of the date that the public water main is installed at the building site.

- When asked my opinion on whether I think Shoreland should be on municipal water I have said yes and here are some reasons why I feel that way.
 - Fire Chiefs would like to have municipal water and hydrants at all locations it makes our job easier and safer in the case of a fire.
 - If there is a fire at a building with sprinklers not connected to municipal water system we have to bring enough water tenders (tanker trucks) to supply our fire engine that is supplying our hoses as well as water tenders and an engine to supply the sprinkler system so it requires more resources to fight a fire in a sprinklered building that isn't connected to a water main system than one that is connected.
 - Municipal water is a more reliable source of water for a fire protection system.
 - The storage tanks in the current system can only supply water for so long before they run out. A municipal system is much less likely to run out of water.
 - It seems counter productive to do this large of an upgrade to the building and to put new parking lots in without installing the water because if the water main comes at a later time you have to connect anyways so you would likely have to cut into the parking lots and alter the buildings to bring the water into the buildings to connect to the fire protection system.

From: [Ben Andersen](#)
To: [George Stoner](#); [Jackie Nelson](#); [Jack Aupperle](#); [Scott Fredrick](#); [Karl Ostby](#); [Ben Harbach](#); [Joe Smith](#)
Cc: [Jason Peters](#); [Kevin Poirier](#)
Subject: Shoreland HS water main
Date: Monday, February 24, 2025 4:17:07 PM

Dear Village President and Village Board Members

I know many of you have mixed feelings on whether or not to require Shoreland Lutheran HS to have a water main brought to their building as part of the addition to the building. I urge you to require the water main! The Village Board regularly requires developers to do things even if they arnt required by ordinance whether that be Storm Water retention above minimum required amount, fancier siding and building materials, landscaping or changes to designs so that it meets what you want to see in a building. So why not do the same for Munciple Water. The safety value alone for a school should be enough to require it. Below is a comparison of Munciple water vs well and storage tank as it relates to firefighting

Municiple	Well/Storage tank
unlimited supply of water	limited supply of water
water is at pressure from water main and will flow some water even without fire pump	requires a well pump to get water from well to tank and fire pump to supply water from the tank to sprinklers if power to a pump goes out you have nothing.
provides Fire Department hydrants to use to fight a fire	Fire department must truck in water to fight fire and supply sprinkler system

arguments I've heard as to why not to require it.

- It will cost a lot - to that I say yes it will but when you look at cost vs safety, safety should win.
- fires shouldn't grow that big in a sprinklered building so you don't need tons of water... remember that parts of Shoreland are not sprinklered so there is still a possibility of a fire in a no sprinklered section to grow large enough that the sprinklers can't stop it even once it gets to them and new materials such as plastics and batteries are causing fires to burn hotter than ever so while sprinklers do help control fires they don't always

put them out completely.

- It will cost residents money in the area- correct but unfortunately that is part of living in a growing community that hasn't stopped you from requiring water be brought to other sites in the village.
- It isn't required and we only bring water where its required- the Village Board and Water utility needs to understand and have a plan to eventually bring water everywhere in the village. You don't see larger communities like Kenosha or Milwaukee leave areas without Municipal water because they had wells that worked... eventually the entire Village should have Municipal water. Yes, that won't be today, next year or even ten years from now but eventually it will have to be done so with water so close to a development like this, it should be done now.
- This isn't a development its a remodel- here is your definition of a development according to village ordinances on website. which clearly makes it a Development and you are requiring a developer agreement which also implies its a development.

- **DEVELOPMENT**

- Any artificial change to improved or unimproved real estate, including, but not limited to, the construction of buildings, structures or accessory structures; **the construction of additions or alterations to buildings,** structures or accessory structures; the repair of any damaged structure or the improvement or renovation of any structure, regardless of percentage of damage or improvement; the placement of buildings or structures; subdivision layout and site preparation; mining, dredging, filling, grading, paving, excavation or drilling operations; the storage, deposition or extraction of materials or equipment; and the installation, repair or removal of public or private sewage disposal systems or water supply facilities.

[Village of Somers, WI Appendix a - Definitions](#)

Thank you for taking the time to read my email with my thoughts and opinions as it relates to a water main at Shoreland Lutheran. I just want the Village of Somers to be the safest place possible.

Respectfully

Chief Benjamin Andersen

Chief 6300

Village of Somers Fire Rescue

Kenosha Co. Dive Team- Team Coordinator

P.O. Box 197

Somers, WI

Ph Station 1 :262-859-2277 Ext 3

Cell 262-620-0637

bandersen@somers.org



**VILLAGE OF SOMERS
VILLAGE BOARD
MEETING ITEM MEMORANDUM**

MEETING DATE: March 11th, 2025

TO: Village President Stoner and Village Trustees

PREPARED BY: Jason J. Peters, Administrator

AGENDA ITEM: #8 Discussion and possible Action on Change Order #2 from August Winters & Sons, Inc. to increase the contract amount by \$5,554.00 for work on the 45th Avenue Lift Station and 63rd Avenue Lift Station 2023 UD #1 Capital Improvement Project

BACKGROUND:

On March 28th, 2023 the Village Board awarded the contract to refurbish our 45th Avenue (Eaglewood) Lift Station and 63rd Avenue (Lichter) Lift Station to August Winter & Sons, Inc. The contracted amount for the project is \$1,649,700. This amount was allocated to these projects in the approved 2024 CIP. The funds will be coming from UD #1 cash.

Administration, Public Works and August Winters met in April of 2023 for a pre-construction meeting. At this time, it was agreed that formal construction would not start until 2024. A formal neighborhood meeting was held in February with residents of the Lichter and Eaglewood Subdivisions to inform them of the project and the timeline. Work began in March.

August Winter & Sons has submitted a change order #2 for software to relay the necessary SCADA data to the Village. This amount adds \$5,554.00 to the contract. As you may recall in January, change order #1 removed \$17,000.00 from the contract price for items that were not needed. Both projects are still under budget.

The new contract price is \$1,638,254.00.

PRIOR ACTION TAKEN:

Engineer Biwer made the Board aware that these items were forthcoming during his Engineer's Report to the Board during our Work Session on March 5th.

SUGGESTED ACTION/ACTION REQUESTED/COMMENTS:

Engineer Snyder has reviewed the request and recommends approval. In the event that the Village Board agrees with the suggested action, a suggested motion to approve would be as follows:

#8

“Motion to approve Change Order #2 from August Winters & Sons, Inc. to increase the contract amount by \$5,554.00 for work on the 45th Avenue Lift Station and 63rd Avenue Lift Station 2023 UD #1 Capital Improvement Project”

ATTACHMENTS:

Change Order #2 – August Winter & Sons

CHANGE ORDER NO. 2

PROJECT: 45th Avenue and 63rd Avenue Lift Station Replacements

DATE OF ISSUANCE: February 27, 2025

OWNER: Village of Somers
7511 12th Street
Somers, WI 53171

ENGINEER: Baxter & Woodman, Inc.
256 South Pine Street
Burlington, WI 53105

CONTRACTOR: August Winters & Son, Inc.
2323 N. Roemer Road
Appleton, WI 54911

ENGINEER's Project No. 201061.00

Description: Software license for the Supervisory Control and Data Acquisition System (SCADA) related to the number of inputs due to this project. See the attached proposal from SJE (Altronex).

CHANGE IN CONTRACT PRICE:

CHANGE IN CONTRACT TIME:

Original Contract Price: \$1,649,700.00

Substantial Completion: June 30, 2024
Completion: August 31, 2024

Previous Change Orders:
No. to No. 1 (\$17,0000.00)

Change from previous Change Orders: See Below

Current Contract Price: \$1,632,700.00

Substantial Completion: June 30, 2024
Completion: August 31, 2024

Net Increase of this Change Order: \$5,554.00

Contract Price with this Change Order: \$1,638,254.00

PREPARED BY:

APPROVED:

ACCEPTED:

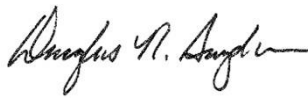
By ¹ 

Douglas R. Snyder P.E.
Project Manager

Village of Somers, WI
By _____
George Stoner
President

August Winter & Son, Inc.
By 

Derek Lewin
Authorized Agent

Walter



Invoice

Original

Seller:
SJE-Rhombus
22650 County Highway 6
Detroit Lakes, MN 56501
USA
Phone: +01 218 847 1317
Email: customer.service@sjeinc.com
VAT No: NL 824184920B01

Shipped From:
Shelter Storage
Attn: SJE-Rhombus Europe
Schelmaatsstraat 21
7575 BC
Oldenzaal
The Netherlands
Phone: +31 548 659 080
Email: europe@sjerhombus.eu

Invoice Number:
CD99547838
Purchase Order Number:
Signed Proposal
Your Reference:

Order Number:
W105443
Invoice Date:
10/30/24
Our Reference:
Kelly Miller
Customer Number:
21316
Customer VAT Number:



Invoice

Original

Our Reference:
Kelly Miller

Purchase Order Number:
Signed Proposal
Tax Identity:

Invoice Date:
10/30/24
Order Date:
9/19/24
Customer Number:
21316

Invoice Number:
CD99547838
Order Number:
W105443
Reference:

Invoice Address:
Somers Town of
7511 12th St
PO Box 197
Somers, WI 53171-0197
US - UNITED STATES OF AMERICA (THE)

Delivery Address:
Somers Town of
7511 12th St
PO Box 197
Somers, WI 53171-0197
US - UNITED STATES OF AMERICA (THE)

Ship Via:
Best Way

Terms of Delivery:
FOB Origin

Due Date:
11/29/24

Master Tracking No:

Terms of Payment:
Net 30 Days

PLEASE REMIT PAYMENT TO:
SJE
P.O. Box 735770
Chicago, IL 60673-5770
Phone: 218-847-1317
Email: Accounts_Receivable@sjeinc.com

Pos	Part Number Description Customer Part No	Sales Quantity	Unit	Unit Price	Line Discount % Order Discount % Order Discount Type	Disc Amt	Net Amount in USD
1	ENG-M Somers, WI - TopView Dialer Software Lic. - \$5,554	1	ea	5,554.00	0.00% 0%	0.00	5,554.00
Sub Total:							5,554.00
Total Excluding Tax:							5,554.00



Invoice

Original

Seller:
SJE-Rhombus
22650 County Highway 6
Detroit Lakes, MN 56501
USA
Phone: +01 218 847 1317
Email: customer.service@sjeinc.com
VAT No: NL 824184920B01

Shipped From:
Shelter Storage
Attn: SJE-Rhombus Europe
Schelmaatstraat 21
7575 BC
Oldenzaal
The Netherlands
Phone: +31 548 659 080
Email: europe@sjerhombus.eu

Invoice Number:
CD99547838
Purchase Order Number:
Signed Proposal
Your Reference:

Order Number:
W105443
Invoice Date:
10/30/24
Our Reference:
Kelly Miller
Customer Number:
21316
Customer VAT Number:



Invoice

Original

Our Reference:
Kelly Miller

Purchase Order Number:
Signed Proposal
Tax Identity:

Invoice Date:
10/30/24
Order Date:
9/19/24
Customer Number:
21316

Invoice Number:
CD99547838
Order Number:
W105443
Reference:

Pos	Part Number Description Customer Part No	Sales Quantity	Unit	Unit Price	Line Discount % Order Discount % Order Discount Type	Disc Amt	Net Amount in USD
-----	--	----------------	------	------------	--	----------	-------------------

Total Tax:	0.00
Invoice Amount to Pay:	5,554.00

Past due balances may be subject to a finance charge of 1.5% per month; 18% per annum.



Customer Statement of Account

SJE

Print Date 12/12/24 Page 1
 Currency USD Balance Date 12/12/24
 Customer Id: 21316 Tax No:

For questions, please contact:
 Accounts Receivable
 218-847-1317
 accounts_receivable@sjeinc.com

Please remit payment to :
 22650 County Highway 6
 Detroit Lakes, MN 56501

Somers Town of
 7511 12th St
 PO Box 197
 Somers, WI 53171-0197

Trans Type	Document No	Document Date	Due Date	Reminder Date	Reminder Level	Document Amount	Open Amount
Invoice	CD-99547838	10/30/24	11/29/24			5,554.00	5,554.00

Balance Per 12/12/24 5,554.00

Not Due	Due 0 - 30 Days	Due 31 - 90 Days	Due 91 - 180 Days	Due More Than 180 Days
0.00	5,554.00	0.00	0.00	0.00

Visit Address Invoice Address Phone Fax Bank Giro Postal Giro Tax Number 9411297816

**VILLAGE OF SOMERS
VILLAGE BOARD
MEETING ITEM MEMORANDUM**

MEETING DATE: March 11th, 2025

TO: Village President Stoner and Village Trustees

PREPARED BY: Jason J. Peters, Administrator

AGENDA ITEM: #9 Action on request from Dimitri Fridman to build a berm at residence located at 343 Sheridan Road

BACKGROUND:

Dimitri Fridman bought the property at 343 Sheridan Rd. last year. He is in the process of building a new residence on the property with Wausau Homes. In the process, the builder reached out to the Village Building Inspector as they plan to build a berm along Sheridan Road to shield the residence.

Ordinance 14.256 (a copy provided below) requires owners who want to build a berm to get Village Board approval.

§ 14.265BERMS.

- (A) Purpose. The land forms and landscape will be preserved in their natural state, insofar as practicable, by minimizing soil and tree removal that is not essential to project development and by retaining grades and contours in keeping with the general appearance of neighboring developed areas. No berm shall be constructed which results in a rate of storm and surface water runoff from the parcel upon which the berm is constructed, either during construction or after completion of the construction of the berm, which is greater than the rate of runoff therefrom onto adjoining parcels which existed prior to the commencement of construction of the berm.
- (B) Definition. For purposes of this ordinance, any grading, regrading, deposit or other accumulation of earth or dirt which raises the elevation of existing topography 18 inches or more for the purpose of or which has the effect of acting as a barrier, screen or vision shield, with or without the addition of vegetation planted thereon, shall be considered a berm.

(C) Berm Construction. *No owner, lessee, occupier of land, contractor or any agent or representative of any of the foregoing shall construct a berm without first obtaining plan review and approval by the Village Board.* The Board may impose such conditions or requirements as are consistent with these ordinances in issuing a permit for the construction of a berm. No berm shall be constructed which exceeds six feet in height. For purposes of this sub-paragraph, the berm shall be measured from the toe to the top, taking existing topography into consideration. Prior to commencement of construction, the applicant or his agent or representative shall provide topographic elevations demonstrating existing topography. The burden of demonstrating pre-construction topographic elevations shall be on the party seeking to construct the berm. In no case shall the toe of a berm be located closer than five feet to any property line and in every case the berm shall be designed and shall operate such that storm and surface water shall be retained on the berm parcel to the extent necessary to assure that the rate of storm and surface water runoff from such real estate, both during construction and after completion of construction of the berm, shall not be greater than the rate of runoff therefrom onto adjoining parcels which existed prior to commencement of berm construction. The party seeking construction of the berm shall comply with all relevant provisions of the design standards contained in § 18.27 of these ordinances. *(emphasis added)*

PRIOR ACTION TAKEN:

This matter was reviewed by the Board at our March 5th Work Session.

SUGGESTED ACTION/ACTION REQUESTED/COMMENTS:

Building Inspector Seymour has reviewed the application and staff would recommend approval. In the event that the Village Board agrees with the suggested action, a suggested motion to approve would be as follows:

“Motion to approve request from Dimitri Fridman to build a berm at residence located at 343 Sheridan Road”

ATTACHMENTS:

Proposed site plan

CIVIL SHEET INDEX:	
SHEET	SHEET TITLE
C1.01	EXISTING CONDITIONS DEMOLITION PLAN
C1.02	PROPOSED SITE PLAN
C1.03	PROPERTY GRADING PLAN

REVISIONS:	
NO.	DESCRIPTION

PSE
 PARISH SURVEY & ENGINEERING
 122 Wisconsin Street, West Bend, WI 53095
 262.346.7800
 www.parishse.com

PROJECT TITLE:
**DIMITRI FRIDMAN
 343 SHERIDAN ROAD
 SOMERS, WI 53171**

PLAN TITLE:
**EXISTING
 CONDITIONS
 DEMOLITION
 PLAN**

DRAWN BY:
WWS
 DESIGNED BY:
EPN
 CHECKED BY:
KJP

PLAN DATE:
1/29/2025

PROJECT NO:
DF-12-24

BID SET

SHEET NO:
C1.01

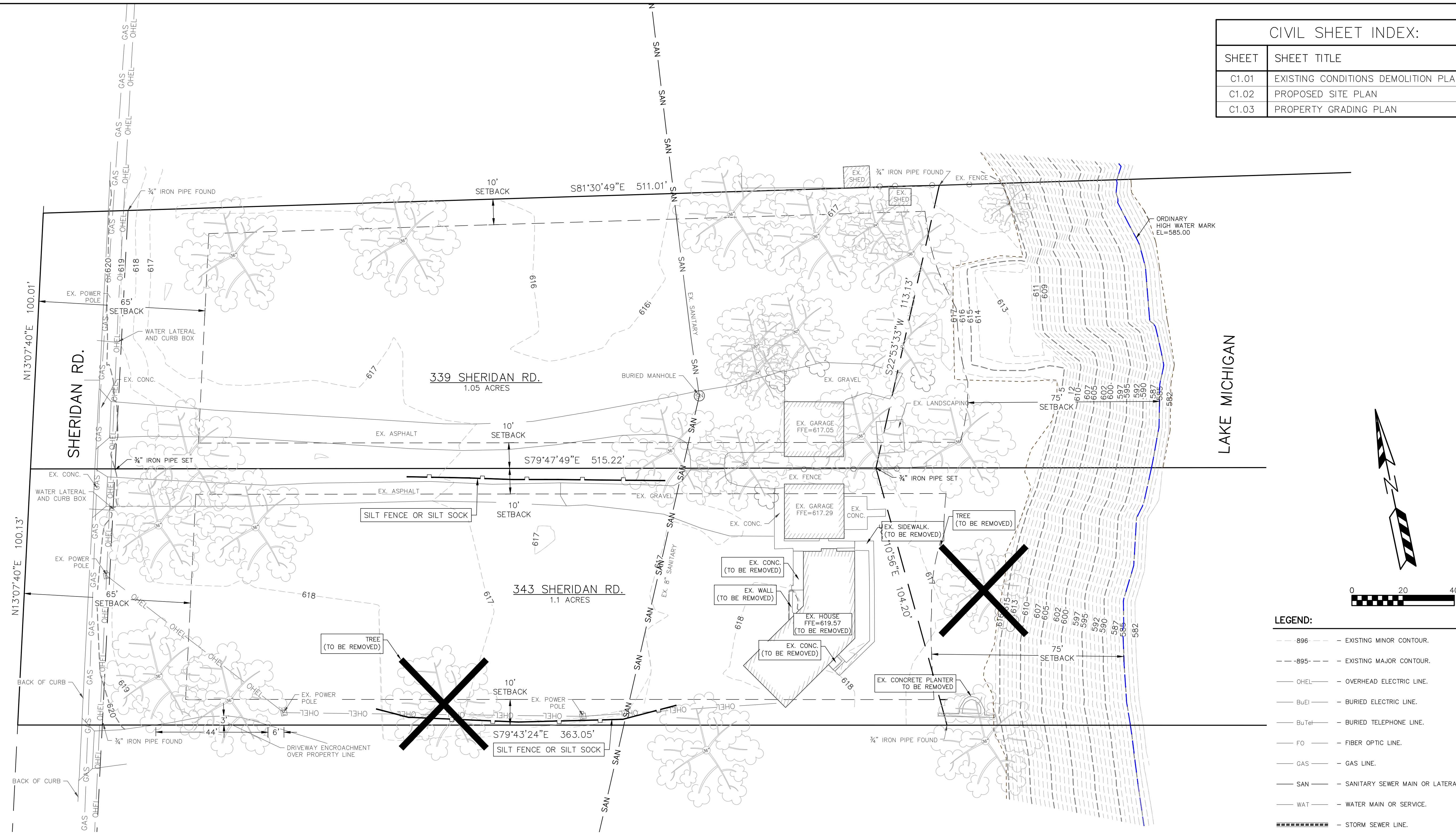

- LEGEND:**
- - - 896 - - - EXISTING MINOR CONTOUR.
 - - - 895 - - - EXISTING MAJOR CONTOUR.
 - OHEL - - - OVERHEAD ELECTRIC LINE.
 - BuEl - - - BURIED ELECTRIC LINE.
 - BuTel - - - BURIED TELEPHONE LINE.
 - FO - - - FIBER OPTIC LINE.
 - GAS - - - GAS LINE.
 - SAN - - - SANITARY SEWER MAIN OR LATERAL.
 - WAT - - - WATER MAIN OR SERVICE.
 - - - - - STORM SEWER LINE.
 - (ELEC) - - - ELECTRIC METER.
 - (GAS) - - - GAS METER.
 - (GAS) - - - GAS VALVE.
 - (FH) - - - FIRE HYDRANT.
 - (PP) - - - POWER POLE.
 - (SN) - - - SANITARY SEWER MANHOLE.
 - (ST) - - - STORM SEWER MANHOLE.
 - (S) - - - STORM SEWER INLET.
 - (T) - - - TELEPHONE PEDESTAL.
 - (TRAN) - - - TRANSFORMER.
 - (W) - - - WATER VALVE.

UTILITY NOTE:

- SANITARY SEWER LOCATION ON 339 SHERIDAN ROAD IS BASED ON MARKINGS PROVIDED BY THE UTILITY COMPANY. SANITARY SEWER LOCATION ON 343 IS APPROXIMATED BASED ON AS-BUILT PLANS PROVIDED BY THE VILLAGE OF SOMMERS.

- CONSTRUCTION NOTES:**
- DREDGING WITHIN THE LAKE IS NOT ALLOWED.
 - REMOVE EXISTING REVETMENT PRIOR TO GRADING.
 - STOCKPILE EXISTING REVETMENT AT TOP OF BLUFF AT LOCATION AGREED UPON WITH THE OWNER.
 - EXISTING REVETMENT MATERIAL MAY BE REUSED IF MEETING THE SPECIFICATIONS FOR MATERIAL SIZE.
 - REGRADE BLUFF PER GRADING PLAN.
 - INSTALL REVETMENT PER DETAILS.
 - APPLY TOPSOIL AND SEEDING TO STABILIZE THE REMAINING BLUFF SLOPE.
 - SEEDING SHALL BE WIDOT NO. 75 OR APPROVED EQUAL.

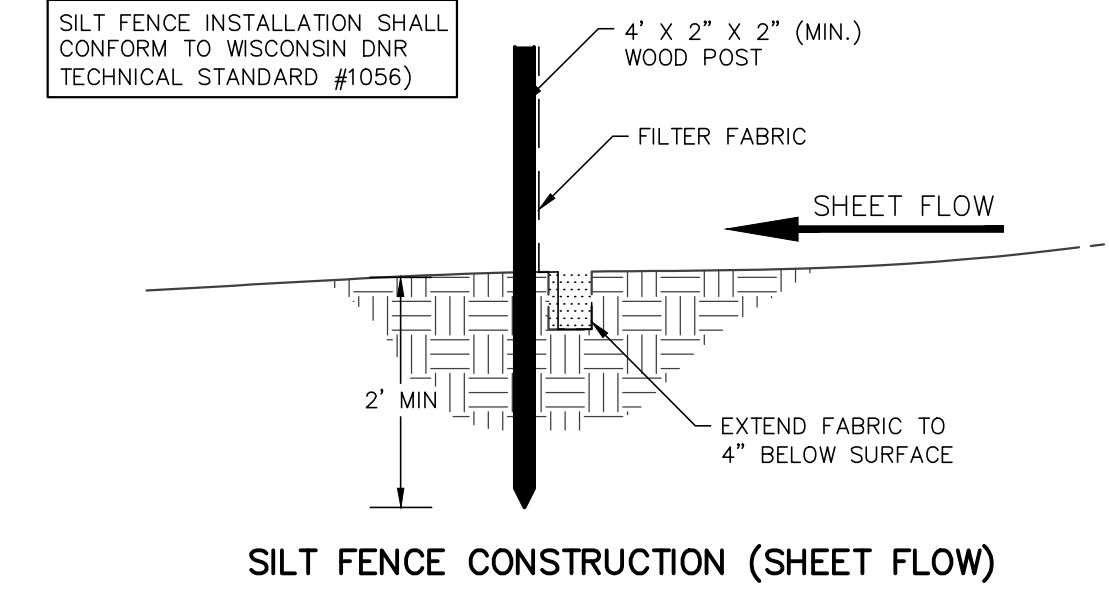
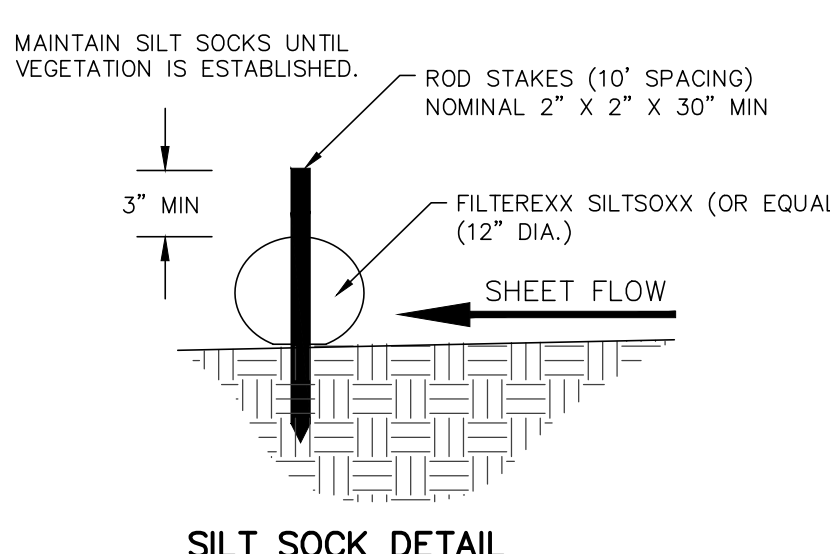

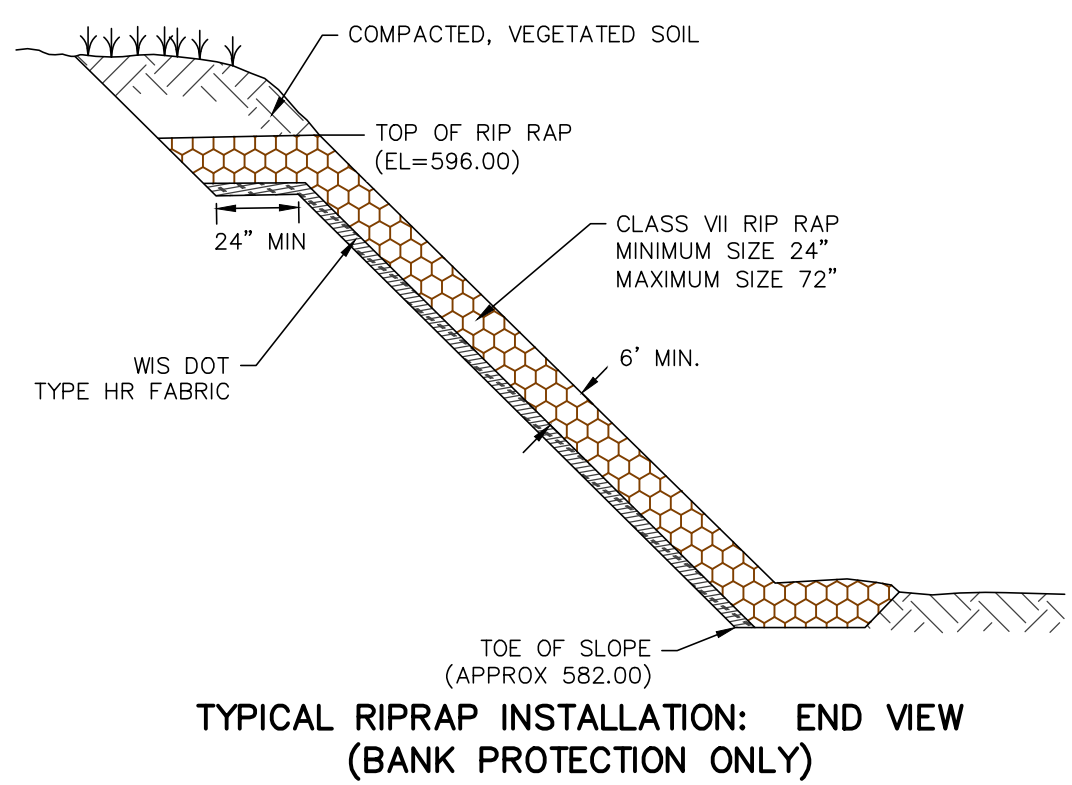
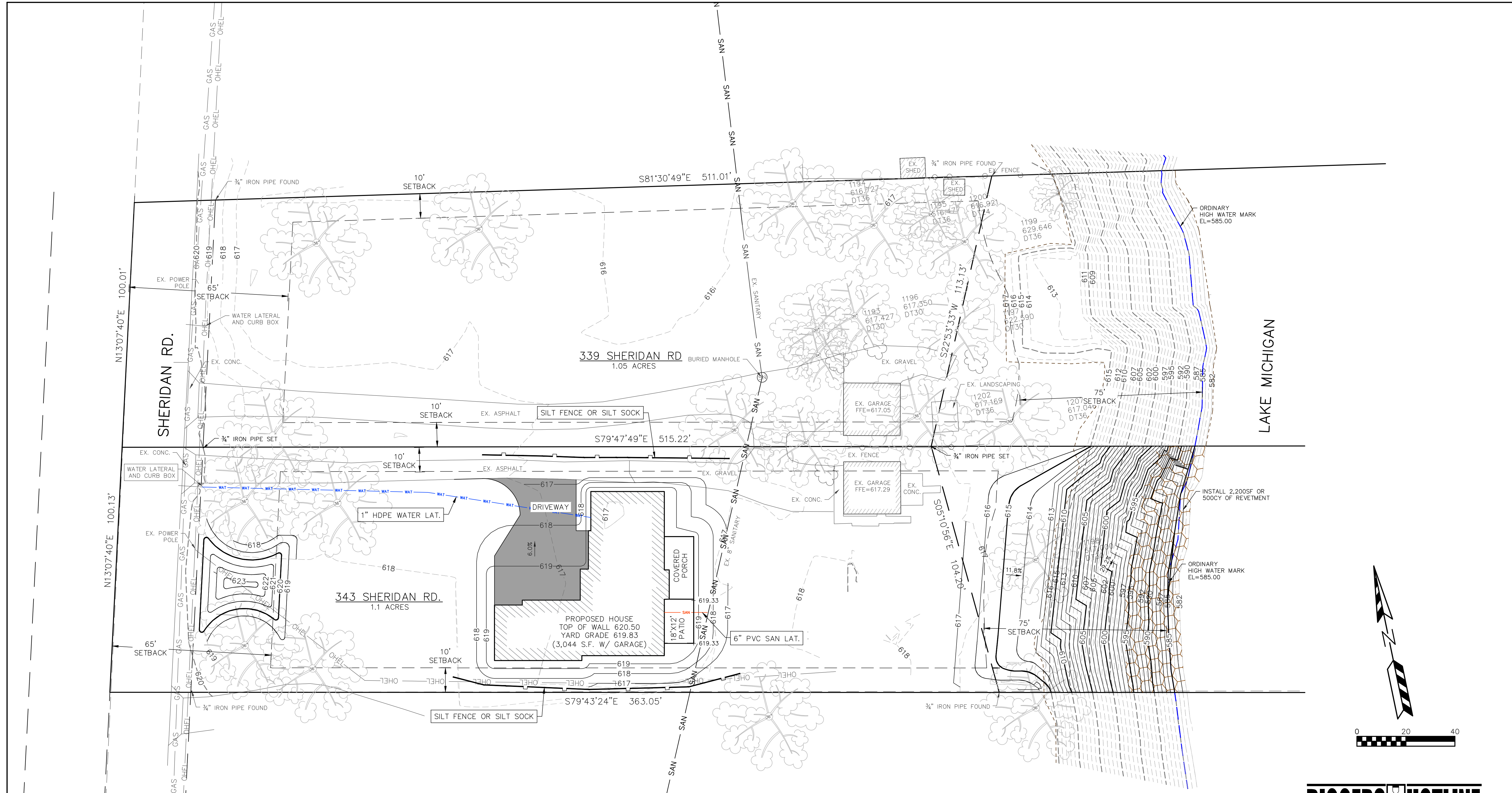

- SPECIFICATIONS FOR GRADING & EROSION CONTROL:**
1. THE CONTRACTOR SHALL ASSUME SOLE RESPONSIBILITY FOR THE COMPUTATIONS OF ALL GRADING AND FOR ACTUAL SOIL BALANCE, THE CONTRACTOR SHALL IMPORT OR EXPORT MATERIAL AS NECESSARY TO COMPLETE THE PROJECT. CONTRACTOR SHALL NOTIFY OWNER OF THE NEED TO IMPORT OR HAUL OFF SOIL. ON-SITE LOCATIONS SUITABLE FOR BORROW OR FILL MAY BE PRESENT. COORDINATE WITH OWNER.
 2. THE CONTRACTOR IS RESPONSIBLE FOR VERIFYING SOIL CONDITIONS PRIOR TO COMMENCEMENT OF CONSTRUCTION.
 3. SITE SHALL BE CLEARED TO THE LIMITS SHOWN ON THE PLANS. REMOVE VEGETATION FROM THE SITE BURNING IS NOT PERMITTED. PROTECT TREES AND OTHER FEATURES FROM DAMAGE WITH FENCING.
 4. ALL FILL SHALL BE CONSIDERED STRUCTURAL FILL AND SHALL BE PLACED IN ACCORDANCE WITH THE FOLLOWING: THE COMPACTED FILL SUBGRADE SHALL CONSIST OF AND SHALL BE UNDERLAIN BY SUITABLE BEARING MATERIALS, FREE OF ALL ORGANIC, FROZEN OR OTHER DELETERIOUS MATERIAL. PREPARATION OF THE SUBGRADE, AFTER STRIPPING, THE COMPACTED FILL MATERIALS SHALL BE FREE OF ANY DELETERIOUS, ORGANIC OR FROZEN MATTER AND SHALL HAVE A MAXIMUM LIQUID LIMIT (ASTM D-423) AND PLASTICITY INDEX (ASTM D-424) IF 30 AND 10 RESPECTFULLY, UNLESS SPECIFICALLY TESTED AND FOUND TO HAVE LOW EXPANSIVE PROPERTIES AND APPROVED BY AN EXPERIENCED SOILS ENGINEER, THE GENERAL STANDARD FOR COMPACTION OF FILL AND THE GRADED SURFACE SHALL BE 90 PERCENT OF THE STANDARD PROCTOR (ASTM D-398) MAXIMUM DENSITY.
 5. TOPSOIL SHALL BE FREE OF DELETERIOUS MATERIALS, ROOTS, OLD VEGETATION, ROCKS OVER 2" DIAMETER AND SHALL NOT BE EXCESSIVELY CLAYEY IN NATURE. NO CLUMPS LARGER THAN 4" ARE ACCEPTABLE. TOPSOIL MAY BE AMENDED AS NEEDED WITH SAND OR COMPOST TO BE LOOSE WHEN SPREAD.
 6. EROSION CONTROL DEVICES SHALL BE INSTALLED PRIOR TO GRADING OPERATIONS AND SHALL BE PROPERLY MAINTAINED FOR MAXIMUM EFFECTIVENESS UNTIL VEGETATION IS ESTABLISHED. ALL EROSION CONTROL MEASURES AND STRUCTURES SERVING THE SITE MUST BE INSPECTED AT LEAST WEEKLY OR WITHIN 24 HOURS OF A 0.5 INCH RAIN EVENT. ALL MAINTENANCE WILL FOLLOW AN INSPECTION WITHIN 24 HOURS.
 7. CUT AND FILL SLOPES SHALL BE NO GREATER THAN 2:0:1.
 8. EROSION CONTROL IS THE RESPONSIBILITY OF THE CONTRACTOR UNTIL ACCEPTANCE OF THIS PROJECT. EROSION CONTROL MEASURES AS SHOWN SHALL BE THE MINIMUM PRECAUTIONS THAT WILL BE ALLOWED. THE CONTRACTOR SHALL BE RESPONSIBLE FOR RECOGNIZING AND CORRECTING ALL EROSION CONTROL PROBLEMS THAT ARE A RESULT OF CONSTRUCTION ACTIVITIES. ADDITIONAL EROSION CONTROL MEASURES, AS REQUESTED IN WRITING BY THE STATE OR LOCAL INSPECTORS, OR THE DEVELOPER'S ENGINEER, SHALL BE INSTALLED WITHIN 24 HOURS.

- CONSTRUCTION NOTES:**
1. DREDGING WITHIN THE LAKE IS NOT ALLOWED.
 2. REMOVE EXISTING REVETMENT PRIOR TO GRADING.
 3. STOCKPILE EXISTING REVETMENT AT TOP OF BLUFF AT LOCATION AGREED UPON WITH THE OWNER. EXISTING REVETMENT MATERIAL MAY BE REUSED IF MEETING THE SPECIFICATIONS FOR MATERIAL SIZE.
 4. REGRADE BLUFF PER GRADING PLAN.
 5. INSTALL REVETMENT PER DETAILS.
 6. APPLY TOPSOIL AND SEEDING TO STABILIZE THE REMAINING BLUFF SLOPE.
 7. SEEDING SHALL BE WIDOT NO. 75 OR APPROVED EQUAL.

- UTILITY NOTE:**
1. SANITARY SEWER LOCATION ON 339 SHERIDAN ROAD IS BASED ON MARKINGS PROVIDED BY THE UTILITY COMPANY. SANITARY SEWER LOCATION ON 343 IS APPROXIMATED BASED ON AS-BUILT PLANS PROVIDED BY THE VILLAGE OF SOMMERS.

DIGGERS HOTLINE
 Dial 811 or (800)242-8511
 www.DiggersHotline.com

- LEGEND:**
- - - 936 - - - EXISTING MINOR CONTOUR.
 - - - 935 - - - EXISTING MAJOR CONTOUR.
 - 936 — — PROPOSED MINOR CONTOUR.
 - 935 — — PROPOSED MAJOR CONTOUR.
 - EX 934.23 - EXISTING SPOT ELEVATION.
 - 934.23 - PROPOSED CURB FLANGE ELEVATION.

REVISIONS:	
NO.	DESCRIPTION

PSE
 PARISH SURVEY & ENGINEERING
 122 Wisconsin Street, West Bend, WI 53095
 262.346.7800 www.parishse.com

PROJECT TITLE:
**DIMITRI FRIDMAN
 343 SHERIDAN ROAD
 SOMMERS, WI 53171**

PLAN TITLE:
**PROPERTY
 GRADING
 PLAN**

DRAWN BY:
WWS
 DESIGNED BY:
EPN
 CHECKED BY:
KJP

PLAN DATE:
1/29/2025

PROJECT NO:
DF-12-241

BID SET

SHEET NO:
C1.03

**VILLAGE OF SOMERS
VILLAGE BOARD MEETING
ITEM MEMORANDUM**

WORK SESSION: March 11, 2025

TO: Village President Stoner and Board of Trustees

PREPARED BY: Wendy Burnette, Clerk/Treasurer

AGENDA ITEM: #10 Action on request for approval of a Recurring Special Event Application from the J. Smith Farms, Inc. (Jerry Smith Farm) located at 7150 18th Street

#11 Action on request for approval of a Recurring Special Event Application from the Petrifying Springs Beer Garden LLC located at Petrifying Springs County Park Pavilion #1 7th Street

#12 Action on request for approval of a Recurring Special Event Application from the Hyslop Foundation, Inc. (Hawthorn Hollow Nature Sanctuary & Arboretum) located at 880 Green Bay Road

BACKGROUND:

On January 24, 2023, the Board passed Ordinance No 2023-003 pertaining to Special Event permits. This created Recurring Special Event Permits to certain zoning located in the PR-1, A-2 or I-1 districts. The expiration date of the previous years permit is March 31st.

The above-mentioned establishments in the Village of Somers have submitted their Recurring Special Events applications. Applications are included.

Building Inspections & Fire Inspections will be conducted once the establishments are up and running.

PRIOR ACTION TAKEN:

The above referenced applications were discussed at the March 4, 2025, Work Session.

SUGGESTED ACTION/ACTION REQUESTED/COMMENTS:

Staff has reviewed the applications and recommends approval of the submitted Recurring Special Event Applications. In the event that the Village Board agrees with the suggested action, a suggested motion to approve would be as follows:

#10

“Motion to approve Recurring Special Event Application from the J. Smith Farms, Inc. (Jerry Smith Farm) located at 7150 18th Street”

#11

“Motion to approve Recurring Special Event Application from the Petrifying Springs Beer Garden LLC located at Petrifying Springs County Park Pavilion #1 7th Street.”

#12

“Motion to approve Recurring Special Event Application from the Hyslop Foundation, Inc. (Hawthorn Hollow Nature Sanctuary & Arboretum) located at 880 Green Bay Road”

ATTACHMENTS:

Jerry Smith Farms Application

Petrifying Springs Beer Garden Application

Hawthorn Hollow Nature Sanctuary and Arboretum Application

Letter from Lt. Adam Pisula

Letter from Building Inspector Scott Seymour

Letter from Lt. Tom Gilley



OFFICE USE ONLY
 DATE FILED: 2/5/25
 INITIALS: LB

Village of Somers
 P.O. Box 197
 7511 - 12th Street
 Somers, WI 53171
 262-859-2822

Village of Somers Special Event Permit (Recurring)

Fee: \$ 150.00

On a separate sheet, list the dates of any proposed events, providing a description for each and specifying the proposed hours of operation.

Zoning District of Event Location: A-2 **Note:** If the property is not located in the PR-1, A-2 or I-1 Zoning District, it is not eligible for a Recurring Special Event Permit.

Licensee Name: J. Smith Farms, Inc.
 Corporation, Partnership, or Individual - Must be same name as beer/liquor license (if applicable)

Trade/Event Name: Jerry Smith Farm

Trade/Event Address: 7150 18th ST. Kenosha, WI 53144
Street Zip

If Licensee is a Corporation or LLC, list Agent's Full Name: Amy Kristen Smith

List Date of Birth of Agent (If Corporation/LLC) or Individual: 01-24-1969

Address: 7150 18th ST. Kenosha WI 53144
Street City State Zip

Phone: 262-620-0081 Email: AKSMITH7150@gmail.com
 (Correspondence will be via email if address is given)

Driver's License Number: WI On File
State Number

1. Have you ever received any **tickets** or been charged with any **crimes** or **felonies** in any state? Yes No
 If yes, provide: Charge, State, Date, Result (including pending charges).
 (Examples: Speeding, WI, 5/8/2012, Guilty | Theft, FL, 5/22/2014, Dismissed | DUI, WI, 6/30/2017, Pending)

CHARGE	STATE	DATE	RESULT
Speeding	IL	1992	Guilty
Speeding	WI	1998	Guilty

2. Have you ever had your **driver's license suspended or revoked** in any state? Yes No
 If yes, provide: Charge, State, Date

CHARGE	STATE	DATE

3. Have you ever served or been sentenced to serve time in **jail or prison** in any state? Yes No
 If yes, provide: Charge, State, Date

CHARGE	STATE	DATE

4. Have you ever, while operating a business or engaged in a profession, been convicted of any charges involving unfair trade practices, unethical conduct, or discrimination in any state? Yes No
 If yes, provide: Charge, State, Date Result (Include pending charges).

CHARGE	STATE	DATE	RESULT

5. List the name and address of all employers for which you have worked and/or businesses you have operated in the **past five (5) years**. Jerry Smith Farms
7150 18th St. Kenosha, WI 53144

6. Have you lived at your current home address for the **past five (5) years**? Yes No
 If no, please list all addresses which you have resided at in the past five (5) years.

READ CAREFULLY BEFORE SIGNING: Under penalty provided for by law, the undersigned states that each of the above questions has been truthfully answered to the best of his/her/their knowledge. False or incomplete answers will result in the denial/revocation of permit. (Individual applicants and each member of a partnership must sign; designed corporate officers must sign.)

Amyk Smith

Individual/Partner/Member Signature

2-3-25

Date

PLEASE NOTE: Attached as page 3 and 4 of the application is an **Operational and Security Plan**. This information is required. If not fully and accurately completed, the Special Event Permit application will be considered incomplete and will not proceed to any Committees for consideration until the information is provided.

PLEASE NOTE: Only the owner, lessee or licensee which has the exclusive right to possession of the property is eligible for a Recurring Special Events Permit. Any other person or entity seeking to hold a Special Event at a location which holds a Recurring Special Events Permit must apply for and receive a separate Single Day Special Event Permit

PLEASE NOTE: Special Events Permits confer no rights regarding alcohol licensing, which must be obtained by separate application and approval.

SPECIAL EVENT PERMIT: OPERATIONAL AND SECURITY PLAN INFORMATION

Operational Plan

Planned Hours* of Operation:

Sunday	Monday	Tuesday	Wednesday	Thursday	Friday	Saturday
Hours: 11AM to 9pm	Hours: 4pm to 9pm	Hours: 4pm to 9pm	Hours: 4pm to 9pm	Hours: 4pm to 9pm	Hours: 11AM to 9pm	Hours: 11AM to 8pm

*be sure to list AM or PM

Legal occupancy limit for the premises: 150 persons

Attach scale drawing of parking plan

Number of off-street parking spaces used to service the premises: 100 parking spaces

Description of the off-street parking spaces used to service the premises: parking lot east of warehouse & parking in front of country store.

Describe the sound amplification equipment to be used (if any): small bands, live music & DJ

Identify any sound mitigation strategies to be implemented: small stage area located in back garden

How will orderly appearance and operation of the establishment be maintained in regard to litter and noise: We maintain trash & noise. We have plenty of staff for trash & security for our events.
Noise - Our summer events end by 6pm, Fall events end by 8pm

Security Plan

Attach scale drawing of elements of Security Plan

Description of clothing to identify security personnel: Security is dressed in vest or t-shirt labeled Security

Are security personnel employees? If not, provide contact information for outside security firm: Yes we have our own security as well as another firm Todd Thorne does our events in the fall 262-945-3346

Plan to handle control and clearance of the parking lot and public right-of-ways adjacent to licensed property during hours of operation and at closing time: Our security team directs traffic as well as 4x4 signage directing customers

How will the entrance line be managed and controlled: Security will manage parking & we have crowd control gates for events w/ long lines

Will any security personnel be armed? Yes No If yes, provide individual names and addresses Todd Thorne does our fall security - you can get all license & information from him. He is a retired Kenosha Police Officer

Plan for unruly patrons, intoxicated patrons, and physical disturbances (including fights): Security is at our events & if any thing happens we would call 911

Underage drinking and fake ID plan: all staff are have gone to bar tender training

Provide the first and last name of all management personnel: Lauren Smith, Linda Timmons-Wosz, Kevin Wosz

READ CAREFULLY BEFORE SIGNING: Under penalty provided for by law, the undersigned states that each of the above questions has been truthfully answered to the best of his/her/their knowledge.

Amy Smith
Individual/Partner/Member Signature

2-3-25
Date



JERRY SMITH PUMPKIN FARM EMERGENCY RESPONDER MAP

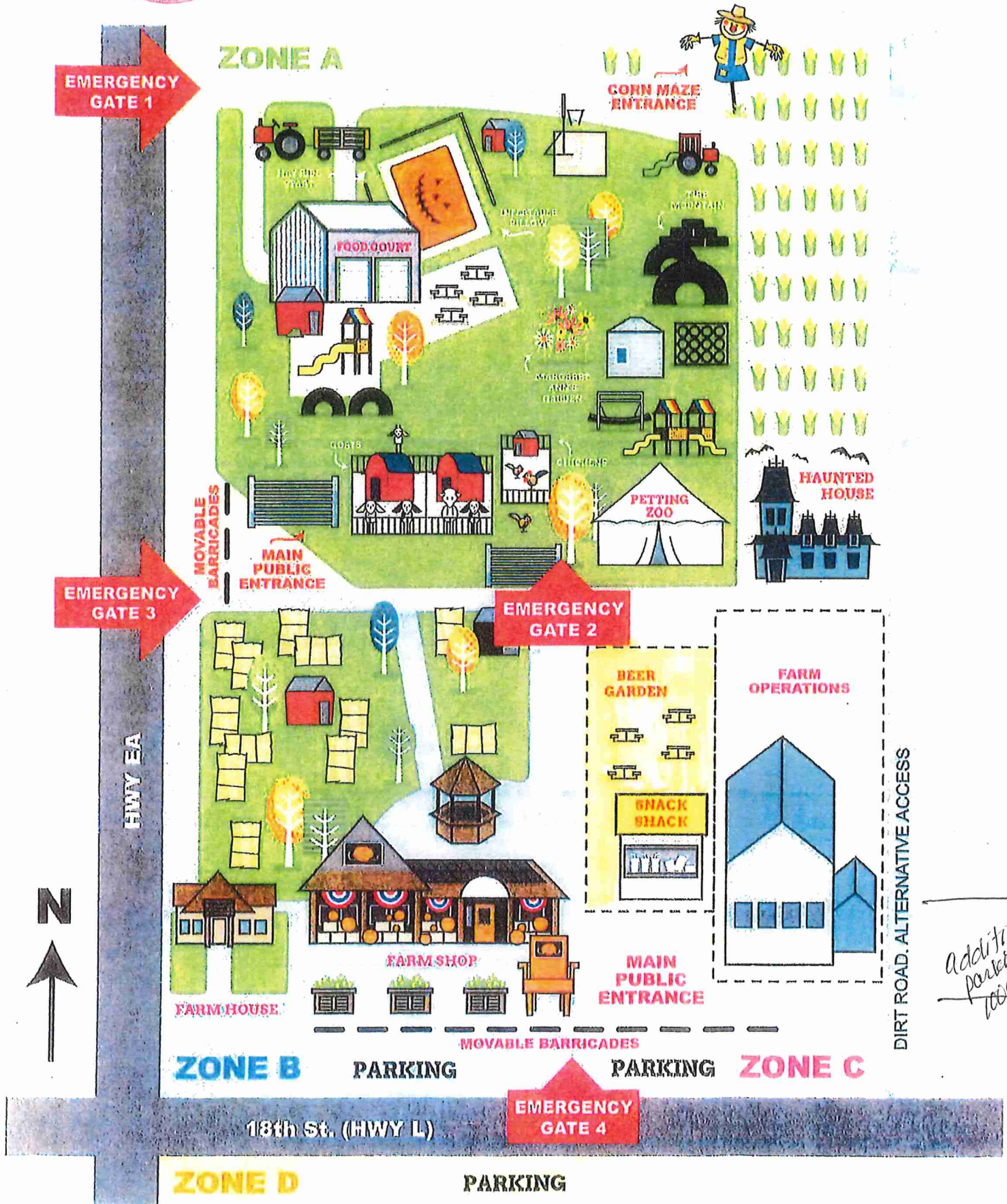



OFFICE USE ONLY
 DATE FILED: 1/22/25
 INITIALS: WB

Village of Somers
 P.O. Box 197
 7511 - 12th Street
 Somers, WI 53171
 262-859-2822

Village of Somers Special Event Permit (Recurring)

Fee: \$ \$150.00

On a separate sheet, list the dates of any proposed events, providing a description for each and specifying the proposed hours of operation.

Zoning District of Event Location: _____ **Note:** If the property is not located in the PR-1, A-2 or I-1 Zoning District, it is not eligible for a Recurring Special Event Permit.

Licensee Name: Petrifying Springs Beer Garden LLC
 Corporation, Partnership, or Individual - **Must be same name as beer/liquor license (if applicable)**

Trade/Event Name: See attached event forms

Trade/Event Address: Petrifying Springs Biergarten Pavilion #1 7th St 53144
Street Zip

If Licensee is a Corporation or LLC, list Agent's Full Name: Anthony DeBartolo

List Date of Birth of Agent (If Corporation/LLC) or Individual: 6-13-76

Address: 4512 19th pl. Kenosha, WI 53144
Street City State Zip

Phone: 224-489-6313 Email: tjd6137@yahoo.com
 (Correspondence will be via email if address is given)

On File

Driver's License Number: WI _____
State Number

1. Have you ever received any **tickets** or been charged with any **crimes** or **felonies** in any state? Yes No
 If yes, provide: Charge, State, Date, Result (including pending charges).
 (Examples: Speeding, WI, 5/8/2012, Guilty | Theft, FL, 5/22/2014, Dismissed | DUI, WI, 6/30/2017, Pending)

CHARGE	STATE	DATE	RESULT

2. Have you ever had your **driver's license suspended or revoked** in any state? Yes No

If yes, provide: Charge, State, Date

CHARGE	STATE	DATE

3. Have you ever served or been sentenced to serve time in **jail or prison** in any state? Yes No

If yes, provide: Charge, State, Date

CHARGE	STATE	DATE

4. Have you ever, while operating a business or engaged in a profession, been convicted of any charges involving unfair trade practices, unethical conduct, or discrimination in any state? Yes No

If yes, provide: Charge, State, Date Result (Include pending charges).

CHARGE	STATE	DATE	RESULT

5. List the name and address of all employers for which you have worked and/or businesses you have operated in the **past five (5) years**. Performance Food Group 5030 Baseline Rd Montgomery, IL 60538

6. Have you lived at your current home address for the **past five (5) years**? Yes No

If no, please list all addresses which you have resided at in the past five (5) years.

4512 19th Place Kenosha, WI 53144

READ CAREFULLY BEFORE SIGNING: Under penalty provided for by law, the undersigned states that each of the above questions has been truthfully answered to the best of his/her/their knowledge. False or incomplete answers will result in the denial/revocation of permit. (Individual applicants and each member of a partnership must sign; designed corporate officers must sign.)

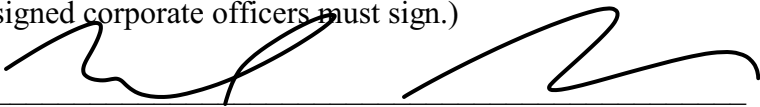

Individual/Partner/Member Signature

1/22/2025

Date

PLEASE NOTE: Attached as page 3 and 4 of the application is an **Operational and Security Plan**. This information is required. If not fully and accurately completed, the Special Event Permit application will be considered incomplete and will not proceed to any Committees for consideration until the information is provided.

PLEASE NOTE: Only the owner, lessee or licensee which has the exclusive right to possession of the property is eligible for a Recurring Special Events Permit. Any other person or entity seeking to hold a Special Event at a location which holds a Recurring Special Events Permit must apply for and receive a separate Single Day Special Event Permit

PLEASE NOTE: Special Events Permits confer no rights regarding alcohol licensing, which must be obtained by separate application and approval.

SPECIAL EVENT PERMIT: OPERATIONAL AND SECURITY PLAN INFORMATION

Operational Plan [SEE ATTACHMENTS FOR SECURITY AND EVENTS](#)

Planned Hours* of Operation:

Sunday	Monday	Tuesday	Wednesday	Thursday	Friday	Saturday
Hours: _____	Hours: _____	Hours: _____	Hours: _____	Hours: _____	Hours: _____	Hours: _____
to _____	to _____	to _____	to _____	to _____	to _____	to _____

*be sure to list AM or PM

Legal occupancy limit for the premises: _____ persons

Attach scale drawing of parking plan

Number of off-street parking spaces used to service the premises: _____ parking spaces

Description of the off-street parking spaces used to service the premises: _____

Describe the sound amplification equipment to be used (if any): _____

Identify any sound mitigation strategies to be implemented: _____

How will orderly appearance and operation of the establishment be maintained in regard to litter and noise: _____

Security Plan

Attach scale drawing of elements of Security Plan

Description of clothing to identify security personnel: _____

Are security personnel employees? If not, provide contact information for outside security firm: _____

Plan to handle control and clearance of the parking lot and public right-of-ways adjacent to licensed property during hours of operation and at closing time: _____

How will the entrance line be managed and controlled: _____

Will any security personnel be armed? Yes No If yes, provide individual names and addresses

Plan for unruly patrons, intoxicated patrons, and physical disturbances (including fights): _____

Underage drinking and fake ID plan: _____

Provide the first and last name of all management personnel: _____

READ CAREFULLY BEFORE SIGNING: Under penalty provided for by law, the undersigned states that each of the above questions has been truthfully answered to the best of his/her/their knowledge.



Individual/Partner/Member Signature

1/22/2024

Date

From: [Petrifying Springs Biergarten](#)
To: [Wendy Burnette](#)
Subject: Parking map
Date: Tuesday, February 25, 2025 4:35:32 PM

Caution: This email originated from outside the organization. Do not click links or open attachments unless you recognize and trust the sender.



PROST,

From Petrifying Springs Biergarten

Phone: 414-839-9170

Email: petsbeergarden@gmail.com

Address: 5555 7th Street, Kenosha, WI 53144 Pavilion #1



Security Plan: 12.5 (C) (2)

- (a) Security personal will only be used for Co-Sponsored County events that extend outside the premise
Depending upon the size of the event 1-3 personal will be employed for the sole purpose of crowd control or to intervene with anyone that appears to be disorderly
- (b) (i) parking lots inside the park do not require vehicles to be left overnight and are monitored by the parks night staff. Cross walks are visible from main parking lot to the Biergarten
(ii) Unruly patrons are given an initial warning and then asked to leave if they do not comply
(iii) Patrons who are intoxicated are asked to leave. We first establish if they have driven there if so an Uber is called
(iv) Patron presenting false ID will be recorded and confiscated
- (c) Sheriff's Department will be notified if a situation escalates. Management will try to deescalate situation and remove said parties from premise at different times so the problem does not continue outside premise
- (d) Michael Grab 2/25/79 Tony DeBartolo 6/13/76

(3) Operational Plan:

- (a) Biergarten will be open M-TH 4-9pm Fri-Sat 12-9pm Sun 12-8pm
- (b) Legal Occupancy inside Pavilion 77ppl Outside unlimited
- (c) We have parking for over 175 in main lot and another 500+ in the parking lots with in walking Distance of the Biergarten
- (d) Yes light german background music
- (e) Yes, Light german background music
- (f) Our facility is cleaned inside and out daily. Grass is cut 1-2 per week. Trash is emptied nightly in required trash or recycling bins. Staff is required to walk interior and exterior of premise and pick up any visible trash.
- (g) See included Map
- (h) List of larger events attached



HAWTHORN HOLLOW
NATURE SANCTUARY AND ARBORETUM

Wendy Burnette
Clerk / Treasurer
Village / Town of Somers
7511 12th Street, P.O. Box 197
Somers, WI 53171

February 6, 2025

Ms. Burnette,

Hawthorn Hollow Nature Sanctuary and Arboretum is applying for a Recurring Event Permit for 2025 to allow us to continue holding our major fundraising events such as the Pike River Benefit Concert Series, the Walk in the Woods Art Fair, and the Harvest Hootenanny. If granted the 2025 Recurring Event Permit, will the Village please consider waiving the accompanying fees for these unique and essential fundraising events?

Hawthorn Hollow is owned and operated by the H. Chris Hyslop Foundation, a private 501c(3) non-profit organization. The now 90 acre Nature Sanctuary is comprised of over 3 miles of trails meandering through the woods of the Pike River Valley, virgin and restored prairies, perennial gardens, a Nature Center, 3 Historic Buildings, the Heritage Farmstead, an Observatory, and a 12 acre Arboretum. Hawthorn Hollow hosts over 6,000 students a year with over 30 educational programs. All proceeds from these events provide funds to continue the maintenance operations of this treasured natural resource

We are looking forward to another successful year and hope that you will join us. Please let me know if there are any issues or questions, and thank you for all your help.

Sincerely,

Jeremy Haag
Special Event & Administrative Associate
Hawthorn Hollow Nature Sanctuary and Arboretum



OFFICE USE ONLY
 DATE FILED: 2/6/25
 INITIALS: WB

Village of Somers
 P.O. Box 197
 7511 - 12th Street
 Somers, WI 53171
 262-859-2822

Village of Somers Special Event Permit (Recurring)

Fee: \$ _____

On a separate sheet, list the dates of any proposed events, providing a description for each and specifying the proposed hours of operation.

Zoning District of Event Location: PR-1 **Note:** If the property is not located in the PR-1, A-2 or I-1 Zoning District, it is not eligible for a Recurring Special Event Permit.

Licensee Name: Hyslop Foundation, Inc
 Corporation, Partnership, or Individual - **Must be same name as beer/liquor license (if applicable)**

Trade/Event Name: Hawthorn Hollow Nature Sanctuary & Arboretum

Trade/Event Address: 880 Green Bay Rd, Kenosha, WI 53144
Street Zip

If Licensee is a Corporation or LLC, list Agent's Full Name: TJ Leveque

List Date of Birth of Agent (If Corporation/LLC) or Individual: 11/06/1981

Address: 1904 30th Ave Kenosha WI 53140
Street City State Zip

Phone: 262-552-8196 Email: tj@hawthornhollow.org
 (Correspondence will be via email if address is given)

Driver's License Number: WI On File
State Number

1. Have you ever received any **tickets** or been charged with any **crimes** or **felonies** in any state? **Yes** **No**
 If yes, provide: Charge, State, Date, Result (including pending charges).
 (Examples: Speeding, WI, 5/8/2012, Guilty | Theft, FL, 5/22/2014, Dismissed | DUI, WI, 6/30/2017, Pending)

CHARGE	STATE	DATE	RESULT
Unlawful U/Y Turn-1st Offense	WI	09/30/2022	Dismissed-Prosecutor's Motion

2. Have you ever had your **driver's license suspended** or **revoked** in any state? Yes No
 If yes, provide: Charge, State, Date

CHARGE	STATE	DATE

3. Have you ever served or been sentenced to serve time in **jail** or **prison** in any state? Yes No
 If yes, provide: Charge, State, Date

CHARGE	STATE	DATE

4. Have you ever, while operating a business or engaged in a profession, been convicted of any charges involving unfair trade practices, unethical conduct, or discrimination in any state? Yes No
 If yes, provide: Charge, State, Date Result (Include pending charges).

CHARGE	STATE	DATE	RESULT

5. List the name and address of all employers for which you have worked and/or businesses you have operated in the **past five (5) years**. Hawthorn Hollow , 880 Green Bay Rd, Kenosha, WI 53144

6. Have you lived at your current home address for the **past five (5) years**? Yes No
 If no, please list all addresses which you have resided at in the past five (5) years.

READ CAREFULLY BEFORE SIGNING: Under penalty provided for by law, the undersigned states that each of the above questions has been truthfully answered to the best of his/her/their knowledge. False or incomplete answers will result in the denial/revocation of permit. (Individual applicants and each member of a partnership must sign; designed corporate officers must sign.)

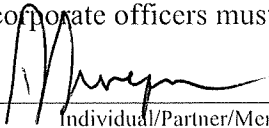
 Individual/Partner/Member Signature

1/28/25
 Date

PLEASE NOTE: Attached as page 3 and 4 of the application is an **Operational and Security Plan**. This information is required. If not fully and accurately completed, the Special Event Permit application will be considered incomplete and will not proceed to any Committees for consideration until the information is provided.

PLEASE NOTE: Only the owner, lessee or licensee which has the exclusive right to possession of the property is eligible for a Recurring Special Events Permit. Any other person or entity seeking to hold a Special Event at a location which holds a Recurring Special Events Permit must apply for and receive a separate Single Day Special Event Permit

PLEASE NOTE: Special Events Permits confer no rights regarding alcohol licensing, which must be obtained by separate application and approval.

SPECIAL EVENT PERMIT: OPERATIONAL AND SECURITY PLAN INFORMATION

Operational Plan

Planned Hours* of Operation:

Sunday	Monday	Tuesday	Wednesday	Thursday	Friday	Saturday
Hours: 8 am To 5 pm	Hours: 8 am To 5 pm	Hours: 8 am To 5 pm	Hours: 8 am To 5 pm	Hours: 8 am To 5 pm	Hours: 8 am To 9 pm	Hours: 8 am To 9 pm

*be sure to list AM or PM

Legal occupancy limit for the premises: _____ persons

Attach scale drawing of parking plan: Attachment one is our Concert/Small Event Parking Plan, attachment two is our Art Fair Parking Plan, and attachment three is our Historic Building Emergency Access Plan.

Number of off-street parking spaces used to service the premises: 560 parking spaces

Description of the off-street parking spaces used to service the premises: Hawthorn Hollow has two parking lots on the premises, our Nature Center lot which holds 30 cars, and our Farm/Event lot which holds 25. In addition, we park cars diagonally at least 10 feet off the entrance road for concerts and other medium-sized events. For the art fair, we convert our arboretum meadow into a five-lane grass parking lot which can hold up to 375 cars with the required clearances.

Describe the sound amplification equipment to be used (if any): We use a 16-channel 1000 w Yamaha powered PA system with two 15-inch main speakers and two floor monitor speakers for the artist. For the art fair, we often have a second stage at the nature center with a second PA system donated for the day. Weddings often utilize a hired DJ who provides their own equipment.

Identify any sound mitigation strategies to be implemented: Volume is always kept as low as possible to reduce impact on neighbors and the general public. Wedding DJ's must set up so speakers face north-west, away from our closest neighbors. The amphitheater (concert location) naturally faces away from our neighbors as well. In the past, we have received no complaints from neighbors or the general public about noise levels from our events to the best of our knowledge.

How will orderly appearance and operation of the establishment be maintained in regard to litter and noise?: We provide numerous garbage and recycling receptacles placed throughout the event area, and these are monitored and emptied when needed. Refuse is then deposited in our garbage and recycling dumpsters, which are emptied once a week by our private sanitation vendor. See above for our noise mitigation plan.

Security Plan

Attach scale drawing of elements of Security Plan: See Attachment Four.

Description of clothing to identify security personnel: Security is provided by Hawthorn Hollow staff and a select group of vetted volunteers. All staff wear lanyards with identification cards attached, and volunteers wear a lanyard that states "volunteer". For the Walk in the Woods Art Fair, all staff and volunteers also wear a bright green t-shirt to make identification easier.

Are security personnel employees? If not, provide contact information for outside security firm: Yes, employees and volunteers.

Plan to handle control and clearance of the parking lot and public right-of-ways adjacent to licensed property during hours of operation and at closing time: The use of off-road diagonal parking spaces for the concert series allows for easy parking lot clearance once the event has concluded. For the art fair, we use numerous volunteers to direct and control parking, as well as enforcing one-way lanes throughout the arboretum lot. This, along with plentiful signage (over 20 different signs are used for art fair parking alone) has allowed us to control and clear the lot with ease.

How will the entrance line be managed and controlled: Our main concern is to keep the entrance line off of public roads, specifically Hwy 31. The actual point of entry, where patrons pay or give tickets, is set approximately 300 ft from the roadside, allowing a large number of vehicles to enter without disrupting traffic. If the line becomes too long, we can open up our Farm/Event parking lot as an additional point of entry, allowing more cars to enter. In the unlikely event that there is still a backup, we would forego entrance donation collection and allow cars to enter the event without stopping for tickets or payment, speeding up the process even more.

Will any security personnel be armed? If yes, provide individual names and addresses: No security personnel at Hawthorn Hollow will be armed.

Plan for unruly patrons, intoxicated patrons, and physical disturbances (including fights): If a patron is found to be unruly or seems to be causing a disturbance, they will be escorted by two security personnel to their vehicle and told to leave the premises (if they don't appear to be intoxicated or a threat to themselves or others). If a fight occurs, all parties will be separated and escorted off the property (again, if not intoxicated or a perceived threat). Patrons who appear to be intoxicated or unruly will not be served any alcohol, and if no other option is available, law enforcement will be asked to intervene. In over 30 years of events at Hawthorn Hollow, law enforcement has never had to intervene in any disturbance with our patrons.

Underage drinking and fake ID plan: When serving alcoholic beverages, we utilize a mandatory ID check and wristband policy for all purchasers. We will not sell any alcoholic beverages to anyone without a wristband (which indicates their ID has been checked and accepted), and we will confiscate any alcoholic beverages in the possession of anyone without a wristband. If an ID is found to be fraudulent, it will be confiscated and turned over to the proper authorities.

Provide the first and last name of all management personnel:

- Timothy J. Leveque, Executive Director
- Dr. William Parker, Observatory Director
- Emily Leonard, Ecologist
- Kailyn Palomares, Naturalist & Education Coordinator
- Chad Jocius, Observatory & Maintenance Manager
- Jeremy W. Haag, Event & Administrative Coordinator

READ CAREFULLY BEFORE SIGNING: Under penalty provided for by law, the undersigned states that each of the above questions has been truthfully answered to the best of his/her/their knowledge.



Individual/Partner/Member Signature

2/6/25
Date

Attachment One: Concert/Small Event Parking Plan

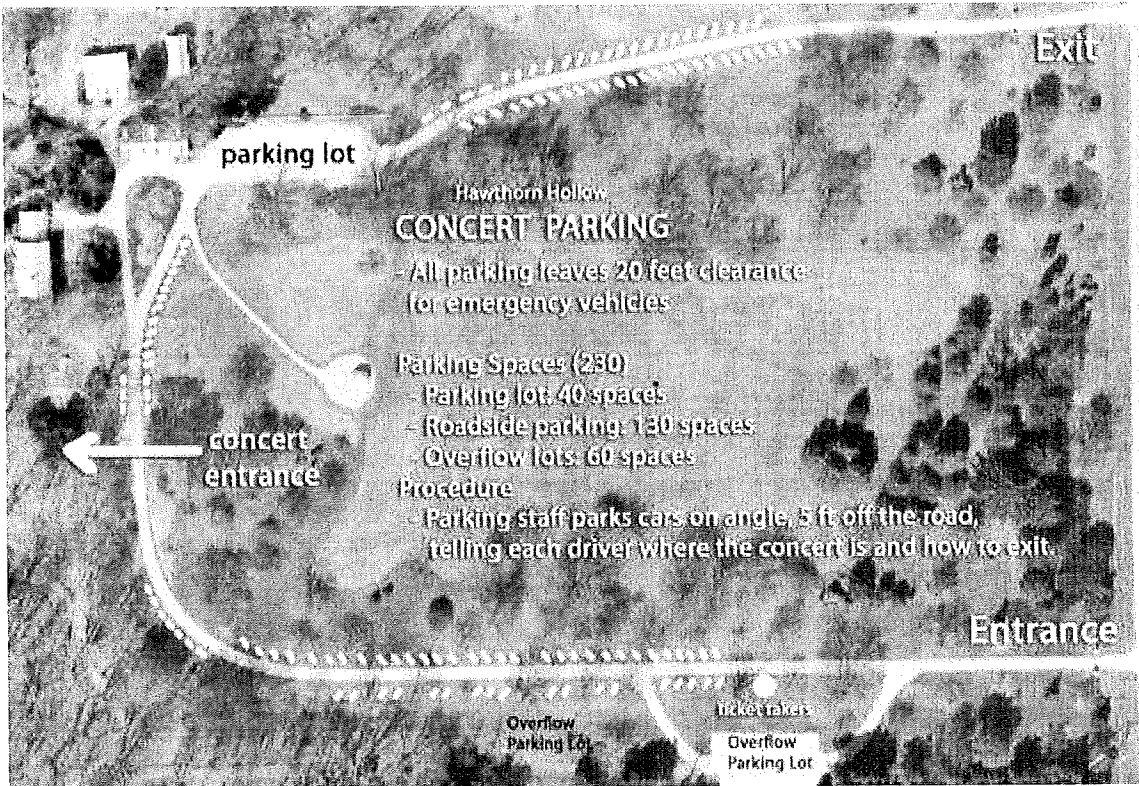

Attachment Two: Art Fair Parking Plan

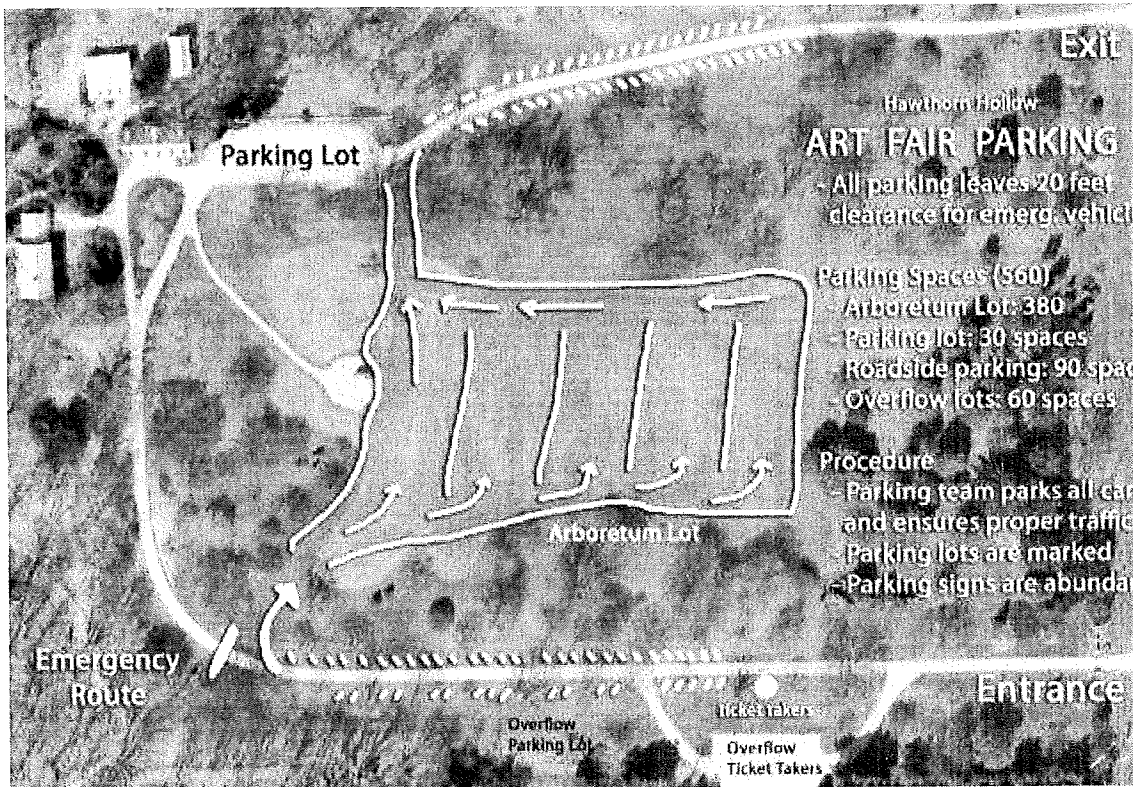

Attachment Three: Historic Buildings Emergency Access Plan



Attachment Four: Gates & Camera Locations

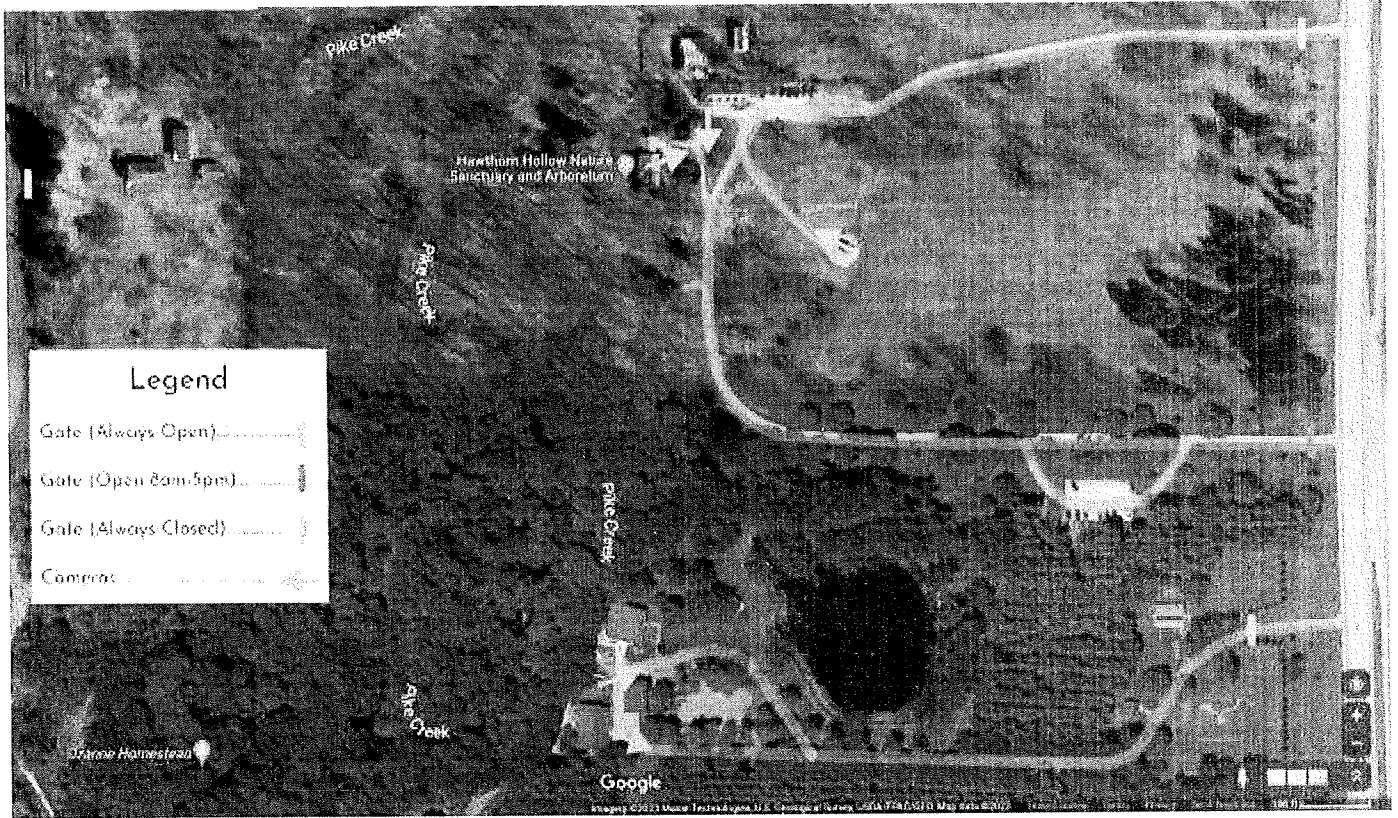

From: [Adam Pisula](#)
To: [Wendy Burnette](#)
Cc: [Ben Andersen](#); [Joe Scruggs](#); [Scott Seymour](#)
Subject: Re: Recurring Special Events
Date: Friday, February 28, 2025 9:32:55 AM
Attachments: [image001.png](#)
[9 10 11e Recurring special events permit fire inspection.pdf](#)
[9 10 11f Building Inspections for Recurring Special Events.pdf](#)

Wendy,

The following properties are up to date on the fire inspections with no outstanding violations:

Petrifying Springs Beer Garden
Jerry Smith Pumpkin Farm
Hawthorn Hallow Nature Sanctuary and Arboretum

There next scheduled inspections are in May/June when they open for the season. The attached letter from Chief is still valid for this season.

Thanks,

Lt. Adam Pisula
Fire Inspector

Get [Outlook for iOS](#)

From: Joe Scruggs <JScruggs@somers.org>
Sent: Friday, February 14, 2025 3:59:20 PM
To: Adam Pisula <APisula@somers.org>
Subject: Fwd: Recurring Special Events

Captain Joe Scruggs
Fire Inspector
Village of Somers
262-620-3285 (direct line)
jscruggs@somers.org (email)
Somers.org (website)

Begin forwarded message:

From: Wendy Burnette <WBurnette@somers.org>
Date: February 13, 2025 at 13:17:42 CST

To: Scott Seymour <SSeymour@somers.org>, Joe Scruggs
<JScruggs@somers.org>
Subject: Recurring Special Events

The yearly recurring special event permits for the following establishments will be ending on March 31st. From what I gathered from last year, inspections at this time of year make it impossible as some of the establishments are seasonal. I've attached the letters from last year, and if you just want to send me something similar, I would really appreciate it. I will be putting these applications on the March 4th work session, so if you could send something by the 24th, I would greatly appreciate it. Please let me know if you have any question.

Petrifying Springs Beer Garden
Jerry Smith Pumpkin Farm
Hawthorn Hallow Nature Sanctuary and Arboretum

*Wendy Burnette
Clerk/Treasurer*

7511 12th Street
P.O. Box 197
Somers, WI 53171
Phone (262)859-2822
Fax (262)-859-2331
Email wburnette@somers.org



7511 12th St | PO Box 197 | Somers, WI 53171
Ph: 262-859-2822 | Fax: 262-859-2331
www.somers.org
Scott Seymour - Building Inspector
sseymour@somers.org

February 24, 2025

To: Somers Village Board and Village Administration

Regarding: Building Inspections for Reoccurring Special Event Permits

The Building Department was asked to inspect Petrifying Springs Beer Garden, Jerry Smith Pumpkin Farm and Hawthorn Hollow Nature Sanctuary and Arboretum sites as part of the reoccurring special event permit process. All three of these properties have seasonal type business models which makes inspecting them off season times difficult.

- All structures on Hawthorn Hollow have been inspected and are in compliance with the Building Codes with the exception of the Pike House
 - The Pike House can be utilized during daylight hours only with no overnights and no use of the elevator without a current inspection and approval from the State of Wisconsin. The exterior wood deck and stairs has been deemed unsafe for public use and should not be used except by maintenance staff in a limited capacity. They are aware of these limitations and the Pike House was not included in their Conditional Use Permit so should have no impact on approval of Special Event Permits.

The Beer Garden and Jeffy Smith Pumpkin Farm inspections will be scheduled as soon as the properties are set up for their operational seasons. Inspecting them now would have no value since they are not set up as they will be when open for the season. I recommend the Village proceed like we did in 2024 where you consider the application now with the understanding staying up to code on building inspections is a mandatory part of the permit and building inspections will be conducted once the businesses are set up for their seasonal operations.

Scott Seymour
Village of Somers
Building Inspections

From: [Tom Gilley](#)
To: [Wendy Burnette](#)
Subject: RE: Recurring Special Events permits
Date: Thursday, February 27, 2025 11:59:06 AM
Attachments: [image001.png](#)
[Copy of Jerry Smith 04-01-24 to 02-25-25.xlsx](#)
[Copy of Pets Biergarten 04-01-24 to 02-25-25 \(002\).xlsx](#)

Good morning Wendy,

I went through the attached calls for Jerry Smith and the Biergarten. There are no significant calls for Hawthorn Hollow. Good to go.

Pets Biergarten- Primary issue was parking complaints. There were four calls made regarding this, one of them being made by Mike Grab the owner. Vehicles either parked on the roadway blocking traffic or parking on the grass. Vehicles were cited by KESO. There were a couple vehicle entries and two minor property damage accidents. Staff reported one child that was found wandering, but the parents were later located. There are some calls on the spreadsheet that occurred in the area, but they were not attributed to the Biergarten. I don't see any issue with the renewal.

Jerry Smith- Two minor accidents in the lot. There was a Disorderly subject called in by security that was throwing corn at another family. Both sides were separated by KESO and no citations issued. There was one domestic violence incident where the parties left but the male was later located and arrested by KESO. There was one reported car entry where wallets were taken. There was one lost child call where the child was located. There was an incident where two female employees who were actors for the haunted maze were inappropriately touched by a male patron. Staff pointed the subject out to KESO and he was arrested for 4th degree sex assault (a misdemeanor) There was only one parking complaint. I don't find any issue with the renewal.

R/S

Tom

Lt. Tom Gilley
Kenosha County Sheriff's Office
1000-55th St Kenosha, WI 53140
Email: Tom.Gilley@kenoshacountywi.gov
Desk: 262-605-5470
Cell: 262-371-5152

From: Wendy Burnette <WBurnette@somers.org>

Sent: Tuesday, February 25, 2025 9:54 AM
To: Tom Gilley <Tom.Gilley@kenoshacountywi.gov>
Subject: RE: Recurring Special Events permits

Caution: This email originated from outside the organization. Do not click links or open attachments unless you recognize and trust the sender.

Thank you. It would be from April 1, 2024 – now.

From: Tom Gilley <Tom.Gilley@kenoshacountywi.gov>
Sent: Tuesday, February 25, 2025 9:46 AM
To: Wendy Burnette <WBurnette@somers.org>
Subject: RE: Recurring Special Events permits

What dates are you looking for?

From: Wendy Burnette <WBurnette@somers.org>
Sent: Tuesday, February 25, 2025 9:34 AM
To: Tom Gilley <Tom.Gilley@kenoshacountywi.gov>
Subject: FW: Recurring Special Events permits
Importance: High

Caution: This email originated from outside the organization. Do not click links or open attachments unless you recognize and trust the sender.

Hi Tom,

Just wanted to follow up on the message below. If you could let me know as soon as you can, I would appreciate it.

From: Wendy Burnette
Sent: Thursday, February 6, 2025 12:30 PM
To: Tom Gilley <Tom.Gilley@kenoshacountywi.gov>
Subject: Recurring Special Events permits

Hi Tom,

Hope all is well. The yearly Recurring Special Events permits will be renewing April 1st. Could you tell me if there were any complaints or problems with the following business last year at any of their events?

Hawthorn Hollow
Petrifying Springs Beer Garden
J. Smith Farms, Inc.

Appreciate your help.

Wendy Burnette
Clerk/Treasurer



7511 12th Street
P.O. Box 197
Somers, WI 53171
Phone (262)859-2822
Fax (262)-859-2331
Email wburnette@somers.org

**VILLAGE OF SOMERS
VILLAGE BOARD
MEETING ITEM MEMORANDUM**

MEETING DATE: March 11th, 2025

TO: Village President Stoner and Village Trustees

PREPARED BY: Jason J. Peters, Administrator

AGENDA ITEM: #13 Action on request to Vacate Public Right of Way from Bear Development on former Willow Creek Condominium project (Parcels 82-4-222-151-0560, 82-4-222-151-0561, 82-4-222-151-056)

#14 Action on request from Bear Development for a release from Developer's Agreement between Somers for the former Willow Creek Condominium project (Parcels 82-4-222-151-0560, 82-4-222-151-0561, 82-4-222-151-0563)

BACKGROUND:

In 2006, the Town of Somers entered into a Developer's Agreement with Bear to develop the Willow Creek site as a condominium project. In 2009, a CSM was recorded that dedicated public right of way for the project. This project never moved forward for a variety of economic reasons.

As you may recall, Bear Development has been working with the Village for several years to bring a project to their Willow Creek site located on CTH E. In 2024, they presented a concept plan for that would have included 33 single-family lots and 32 duplexes. Since this time, the Developer has decided that they wanted to pursue the Willow Creek site with only single-family homes. They will be submitting to the Plan Commission in the near future for a preliminary plat that will include approximately 70 single family homes.

In preparation for their upcoming plat submission, Bear Development has requested that the public right of way that was dedicated be vacated. This will allow them to "reconfigure" right of way that will be necessary for their single-family project. Bear will also need to be released from the 2006 Developers Agreement so that this project can move forward.

PRIOR ACTION TAKEN:

This matter was reviewed by the Board at our March 5th Work Session.

SUGGESTED ACTION/ACTION REQUESTED/COMMENTS:

Attorney Davison has reviewed the documents and Staff would recommend that the right of way be vacated, and the development agreement release be executed so this new project can move forward in a timely manner. In the event that the Village Board agrees with the suggested action, a suggested motion to approve would be as follows:

#13

“Motion to approve request to Vacate Public Right of Way from Bear Development on former Willow Creek Condominium project (Parcels 82-4-222-151-0560, 82-4-222-151-0561, 82-4-222-151-056) and directing Staff to execute and record the necessary documentation”

#14

“Motion to approve request from Bear Development for a release from Developer’s Agreement between Somers for the former Willow Creek Condominium project (Parcels 82-4-222-151-0560, 82-4-222-151-0561, 82-4-222-151-0563) and directing Staff to execute and record the necessary documentation”

ATTACHMENTS:

Correspondence from Bear Development

Exhibit for ROW

Proposed Release for Development Agreement

February 18, 2025

Mr. Jason Peters,
Village of Somers Administrator
7511 12th Street
Somers, WI 53171

Dear Mr. Peters:

Bear Development LLC is pleased to submit this letter and the enclosed submittal materials as formal application for Right of Way Vacation for Willow Creek Court, a dedicated public right of way within the Village of Somers. Bear Development is acting on behalf of the owner of record, Berwick Properties, Inc.

Project Summary

Berwick Properties Inc. is the owner of record of approximately 40.05 acres of land in the Village of Somers, commonly known as Willow Creek. The property is located on the south side of CTH E, approximately 1000' west of the intersection of STH 31 and CTH E.

In 2009, the subject property was divided into three (3) separate parcels by Certified Survey Map No. 2556 to accommodate a proposed condominium development. The CSM also served to dedicate Willow Creek Court for public street purposes.

For a variety of reasons, the approved condominium project did not advance. Since then, Berwick Properties has re-envisioned the property as a single-family residential subdivision. The Conceptual Site Plan was approved by the Village along with a Comprehensive Land Use Amendment. The with a street network shown on the Conceptual Site Plan does not align with the previously dedicated right of way.

Berwick Properties, respectfully requests that the public right away of Willow Creek Court be vacated. Berwick Properties owns the property on either side of the dedicated right of way; and upon vacation will take ownership of the former right of way. Bear Development intends to bring forth a Preliminary Plat for Village of Somers review and approval in March 2025. Upon recording the eventual Final Plat, future right away, in a different configuration will be dedicated to the Village of Somers for public street purposes.

We look forward to discussing this request with Village Staff in further detail. Should you have any questions regarding this request, please do not hesitate to contact me. I can be reached at (262) 842-0556 or by email, dan@beardevelopment.com



Phone: 262.694.2327



www.beardevelopment.com



4011 80th Street, Kenosha, WI 53142



Providing Creative Real Estate Solutions to Build Better Communities

Thank you for your time and consideration.

Sincerely,

A handwritten signature in black ink, appearing to read "Daniel Szczap".

Daniel Szczap
Bear Development, LLC



Phone: 262.694.2327



www.beardevelopment.com



4011 80th Street, Kenosha, WI 53142

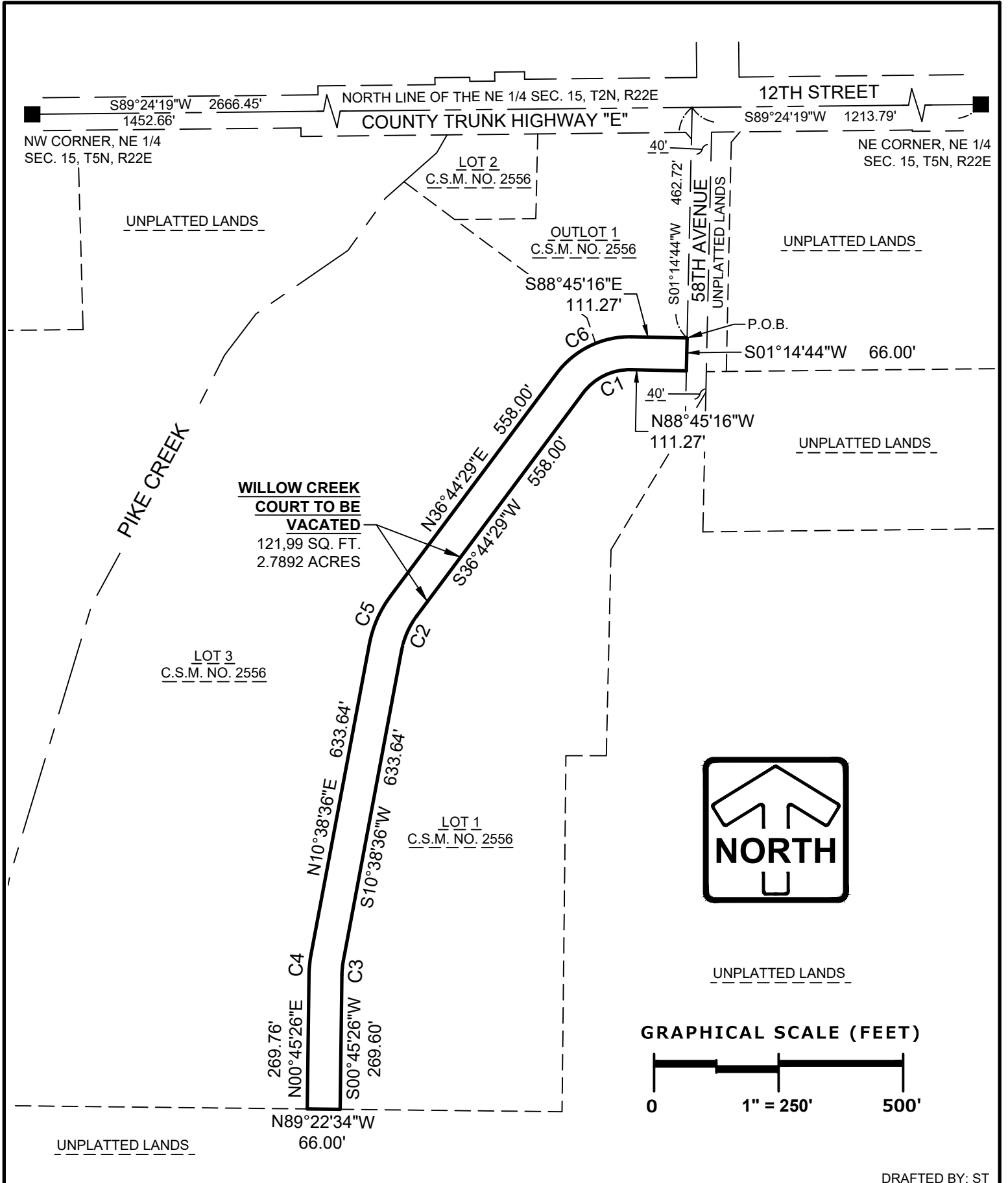

DRAFTED BY: ST

LEGAL DESCRIPTION:

Being a part of the Northeast 1/4, Southeast 1/4 and the Northwest 1/4 of the Northeast 1/4 of Section 15, Township 2 North, Range 22 East, Village of Somers, Kenosha County, Wisconsin, described as follows:

Commencing at the northeast corner of the Northeast 1/4 of said Section 15; thence South 89°24'19" West along the north line of said Northeast 1/4, 1213.79 feet; thence South 01°14'44" West and then along the west right of way line of 58th Avenue, 462.72 feet to the Point of Beginning;

Thence continuing South 01°14'44" West along said west right of way line, 66.00 feet; thence North 88°45'16" West, 111.27 feet to a point of curvature; thence southwesterly 111.30 feet along the arc of said curve to the left, whose radius is 117.00 feet and whose chord bears South 63°59'36" West, 107.15 feet; thence South 36°44'29" West, 558.00 feet to a point of curvature; thence southwesterly 76.07 feet along the arc of said curve to the left, whose radius is 167.00 feet and whose chord bears South 23°42'32" West, 75.41 feet; thence South 10°38'36" West, 633.64 feet to a point of curvature; thence southwesterly 28.82 feet along the arc of said curve to the left, whose radius is 167.00 feet and whose chord bears South 05°42'00" West, 28.78 feet; thence South 00°45'26" West, 269.60 feet; thence North 89°22'34" West, 66.00 feet; thence North 00°45'26" East, 269.76 feet to a point of curvature; thence northeasterly 40.20 feet along the arc of said curve to the right, whose radius is 233.00 feet and whose chord bears North 05°42'00" East, 40.15 feet; thence North 10°38'36" East, 633.64 feet to a point of curvature; thence northeasterly 106.13 feet along the arc of said curve to the right whose radius is 233.00 feet and whose chord bears North 23°42'32" East, 105.22 feet; thence North 36°44'29" East, 558.00 feet to a point of curvature; thence northeasterly 174.08 feet along the arc of said curve to the right, whose radius is 183.00 feet and whose chord bears North 63°59'36" East, 167.59; thence South 88°45'16" East, 111.27 feet to the Point of Beginning.

CURVE TABLE				
CURVE NO.	LENGTH	RADIUS	CHORD BEARING	CHORD LENGTH
C1	111.30'	117.00'	S63°59'36"W	107.15'
C2	76.07'	167.00'	S23°42'32"W	75.41'
C3	28.82'	167.00'	S05°42'00"W	28.78'
C4	40.20'	233.00'	N05°42'00"E	40.15'
C5	106.13'	233.00'	N23°42'32"E	105.22'
C6	174.08'	183.00'	N63°59'36"E	167.59'



**RELEASE OF DEVELOPER'S AGREEMENT
BETWEEN TOWN OF SOMERS & DEVELOPER
FOR "WILLOW CREEK CONDOMINIUMS"**

Document Number

Recording Area

Name and Return Address

Bear Real Estate Group
4011 80th Street
Kenosha, WI 53142
Attn. John Hotvedt

See attached Exhibit A

(Parcel Identification Number)

Drafted by:
John Hotvedt, Vice President – General Counsel
Bear Real Estate Group
4011 80th Street
Kenosha, WI 53142

**RELEASE OF DEVELOPER'S AGREEMENT BETWEEN TOWN OF SOMERS &
DEVELOPER FOR "WILLOW CREEK CONDOMINIUMS"**

For good and valuable consideration, the receipt of which is hereby acknowledged, the undersigned, being the parties bound by and benefitted by the Developer's Agreement between Town of Somers & Berwick Properties, Inc. (as the successor to Willow Creek Developers, LLC) ("Developer") (as hereinafter defined), does hereby release any and all of its respective rights, title and interest to the restrictions and other rights set forth in that certain Developer's Agreement between Town of Somers & Developer for "Willow Creek Condominiums" dated November 15, 2006 and recorded on December 15, 2006, as Document Number 1504604, in the Register of Deed's Office of Kenosha County, Wisconsin, as amended by that certain Amended Developer's Agreement between Town of Somers & Developer for "Willow Creek Condominiums" dated September 30, 2009 and recorded on January 13, 2010, as Document Number 1608767, in the Register of Deed's Office of Kenosha County, Wisconsin (collectively the "Developer's Agreement") as it pertains to the real property described on the attached Exhibit A.

[Signatures appear on the following pages]

IN WITNESS WHEREOF, this Release shall be effective as of the date first set forth below.

Dated this _____ day of _____, 2025.

Village of Somers

By: _____

Name: _____

Title: Village Clerk

STATE OF WISCONSIN)
) SS
COUNTY OF _____)

Personally came before me this ___ day of _____, 2025 the above named _____, the Village Clerk of the Village of Somers, and known to me to be the person who executed the foregoing instrument and acknowledge that he executed the same on behalf of said company by its authority.

*

Notary Public, _____ County, WI
My commission (is)(expires):

DEVELOPER:
Berwick Properties, Inc.

By: _____
Stephen R. Mills, President

STATE OF WISCONSIN)
) SS
COUNTY OF KENOSHA)

Personally came before me this ___ day of _____, 2025 the above named Stephen R. Mills, the President of Berwick Properties, Inc., and known to me to be the person who executed the foregoing instrument and acknowledge that he executed the same on behalf of said company by its authority.

*

Notary Public, Kenosha County, WI
My commission (is)(expires):

EXHIBIT A
Legal Description of Property Released

**VILLAGE OF SOMERS
VILLAGE BOARD
MEETING ITEM MEMORANDUM**

MEETING DATE: March 11, 2025

TO: Village President Stoner and Village Trustees

PREPARED BY: Wendy Burnette, Clerk-Treasurer

AGENDA ITEM: #15 Action on application for Class “B” (Picnic) Beer License from Shoreland Lutheran High School Booster Club for the Connections We Make: Dinner & Auction Event on April 5, 2025. Event to be held at Shoreland Lutheran High School, 9026 12th Street Kenosha, WI 53144

#16 Action on application for Temporary Operators License: Amber Wasurick, for the Shoreland Lutheran High School Shoreland Lutheran High School Booster Club for the Connections We Make: Dinner & Auction Event and request to waive fee

BACKGROUND:

Shoreland Lutheran High School Booster Club is a club organization that was established in 1971. They have approached the Village to request a Class “B” (Picnic) Beer License for the Connections We Make: Dinner & Auction Event for the date listed below.

- April 5, 2025, from 4:30p.m. to 9 p.m. at Shoreland Lutheran High School located at 9026 12th Street.

They have also applied for a temporary operator for Amber Wasurick for the event.

They have also requested to waive associated fees with both applications.

PRIOR ACTION TAKEN:

These matters were reviewed and discussed at our March 4, 2025, Work Session.

SUGGESTED ACTION/ACTION REQUESTED/COMMENTS:

Staff would recommend approval both matters. In the event that the Village Board agrees with the suggested action, a suggested motion to approve would be as follows:

“Motion to approve application for Class “B” (Picnic) Beer License from Shoreland Lutheran High School Booster Club for the Connections We Make: Dinner & Auction Event on April 5, 2025. Event to be held at Shoreland Lutheran High School, 9026 12th Street Kenosha, WI 53144”

“Motion to approve application for Temporary Operators License: Amber Wasurick, for the Shoreland Lutheran High School Shoreland Lutheran High School Booster Club for the Connections We Make: Dinner & Auction Event and request to waive fee”

ATTACHMENTS:

Request to waive fees letter

Temporary Class “B” / “Class B” Retailers License Application

Temporary Operators application

Site Plan

Application for Temporary Class "B" / "Class B" Retailer's License

See Additional Information on reverse side. Contact the municipal clerk if you have questions.

FEE \$ 10

Application Date: 2.6.25

Town Village City of Somers

County of Kenosha

The named organization applies for: (check appropriate box(es).)

A Temporary Class "B" license to sell fermented malt beverages at picnics or similar gatherings under s. 125.26(6), Wis. Stats.

A Temporary "Class B" license to sell wine at picnics or similar gatherings under s. 125.51(10), Wis. Stats.

at the premises described below during a special event beginning 4.5.25 and ending 4.5.25 and agrees to comply with all laws, resolutions, ordinances and regulations (state, federal or local) affecting the sale of fermented malt beverages and/or wine if the license is granted.

1. Organization (check appropriate box) →
- Bona fide Club Church Lodge/Society
 Chamber of Commerce or similar Civic or Trade Organization
 Veteran's Organization Fair Association

(a) Name Shoreland Lutheran H.S. Booster Club

(b) Address 9026 12th Street
(Street) Town Village City

(c) Date organized 11.2016

(d) If corporation, give date of incorporation N/A

(e) If the named organization is not required to hold a Wisconsin seller's permit pursuant to s. 77.54 (7m), Wis. Stats., check this box:

(f) Names and addresses of all officers:

President Alan Ferber 11021 7th Street Sturtevant, WI 53177

Vice President Jody Hafeman 10891 292 Ave Trevor, WI 53179

Secretary Ronda Bailey 341 100th Ave Sturtevant, WI 53177

Treasurer _____

(g) Name and address of manager or person in charge of affair: Paul Sriver
4113 Felicia Run, Kansasville, WI 53177

2. Location of Premises Where Beer and/or Wine Will Be Sold, Served, Consumed, or Stored, and Areas Where Alcohol Beverage Records Will be Stored:

(a) Street number 9026 12th Street Kenosha, WI 53144

(b) Lot _____ Block _____

(c) Do premises occupy all or part of building? part

(d) If part of building, describe fully all premises covered under this application, which floor or floors, or room or rooms, license is to cover:

3. Name of Event

(a) List name of the event Shoreland Presents: A Roaring Twenties Dinner Auction: Gala

(b) Dates of event 04/05/06

DECLARATION

The Officer(s) of the organization, individually and together, declare under penalties of law that the information provided in this application is true and correct to the best of their knowledge and belief.

Officer Al Ferber 2/6/25
(Signature/date)

Shoreland Lutheran Booster Club
(Name of Organization)
 Officer Jody Hafeman 2/6/25
(Signature/date)

Officer Ronda Bailey 2/6/25
(Signature/date)

Officer _____
(Signature/date)

Date Filed with Clerk _____

Date Reported to Council or Board _____

Date Granted by Council _____

License No. _____

Additional Information

May be Granted and Issued only to:

- (1) Bona fide clubs.
- (2) State, county, or local fair associations, or agricultural societies.
- (3) Churches, lodges, or societies that have been in existence for at least 6 months prior to the date of application.
- (4) Posts of veterans organizations.
- (5) Chambers of commerce or similar civic or trade organizations organized under ch. 181, Wis. Stats.

Application:

- (1) Filing: In writing, for each event, on Form AT-315.
- (2) The local licensing authority may act on application or authorize an official or body of the municipality to issue the license. (ss. 125.26(1) and 125.51(1)(a), Wis. Stats.)
- (3) The written application shall be filed with the clerk of the municipality in which premises are located:

Class "B" (Beer):

- a. The governing body shall establish any waiting period before granting of a license for events lasting less than 4 days (s. 125.04(3)(f), Wis. Stats.)
- b. At least 15 days prior to the granting of the license for events lasting 4 or more days.

"Class B" (Wine):

The application shall be filed with the clerk of the local municipality in which the event will be held at least 15 days prior to the granting of the license.

- (4) Seller's Permit: Sec. 77.54 (7m), Wis. Stats., provides an exemption from Wisconsin sales and use taxes relating to certain sales by a nonprofit organization. Check the box if your organization qualifies for the exemption and therefore is not required to hold a seller's permit.
- (5) Publication: Not required.

Fee: Determined by the municipality, but may not exceed \$10. (Exception: No additional fee may be charged if organization is applying for both a Temporary Class "B" and a Temporary "Class B" license for the same event.)

Duration: The day, or consecutive days, that the specified event is in progress. A municipality may issue up to 20 licenses to the same licensee for a single event, if each license is issued for the same date and time.

Restrictions:

- (1) License may not be issued to individuals.
- (2) Licenses to organizations, other than ex-servicemen's organizations, can be issued only for a picnic or similar gathering. They may not be issued for business or social meetings of the organization.
- (3) Licenses for club or organization meetings may be issued only to ex-servicemen's posts.
- (4) License may cover either a specified area or the entire picnic grounds.
- (5) License issued to a county or district fair must cover the entire fairground (ss. 125.26(6) and 125.51(10), Wis. Stats.)
- (6) No license to clubs having any indebtedness to any wholesaler for more than 15 days for beer (s. 125.33(7), Wis. Stats.) and 30 days for wine (s. 125.69(4)(b), Wis. Stats.)
- (7) Licensed operator(s) must be present at all times (ss. 125.26(6), 125.32(2) - Beer; 125.51(10), 125.68(2) - Wine; 125.17)
- (8) The licensed club, club members, or any other persons are not permitted to possess intoxicating liquor on licensed premises on the Temporary Class "B"/"Class B" licensed picnic area. (s. 125.32(6), Wis. Stats.)
- (9) Not more than 2 wine licenses may be issued to any club, county or local fair association, agricultural association, church, lodge, society, chamber of commerce or similar civic or trade organization or veterans' post in any 12 month period. A municipality may issue up to 20 wine licenses to the same licensee if: 1) each license is issued for the same date and times, 2) the licensee is the sponsor of an event held at multiple locations within the municipality on this date and at these times, 3) an admission fee is charged for participation in the event and no additional fee is charged for service of alcohol beverages at the event, and 4) within the immediately preceding 12-month period, the municipality has issued these multiple licenses for fewer than 2 events. In addition, each event for which multiple licenses are issued shall count as one license toward the 2-license limit.
- (10) Licensed organizations must purchase their product from a licensed wholesaler.

NOTE: Most coolers presently on the market have a fermented malt beverage base allowing sale under a beer license, e.g. Bartles and James, Seagrams, etc.



TEMPORARY OPERATOR'S LICENSE APPLICATION

For one (1) to fourteen (14) consecutive days. Two(2) per calendar year

Temporary Operator (\$10.00)

FILLING OUT YOUR APPLICATION

1. Should your information on this application not be complete, correct or illegible, your license may be denied.
2. Applications must attach copy of Responsible Beverage Server Class Certificate; or current license from another Wisconsin Municipality.
3. Attach a copy of the front and back of your valid driver's license or state issued photo identification card.

REVIEW OF YOUR APPLICATION

1. Somers will perform a background check and recommend approval or denial.
2. If you are denied, you may request an appeal through the Village Clerk's office and your appeal will be placed on the next Village Board agenda. If your application is denied, the fee is non-refundable, and you cannot reapply for a minimum period of six months. Meetings of the Village Board are open to the public. This application is a public record and subject to release.

PLEASE PRINT CLEARLY			
FIRST NAME Amber	M.I. L	LAST NAME Wasuricka	
OTHER NAMES, ALIASES, OR BIRTHDATES EVER USED Amber L. Land			
DATE OF BIRTH 08/24/1981	AGE 43	DRIVER LICENSE NO.	ISSUING STATE WI
HOME ADDRESS 8927 - 29th Avenue		CITY Kenosha	STATE & ZIP WI 53143
PHONE 262-515-3380	EMAIL wasuricka@slhs.us		
MAILING ADDRESS (IF DIFFERENT)		CITY	STATE & ZIP
SPONSORING ORGANIZATION: Shoreland Lutheran H.S.			
EVENT: Fundraising Dinner Auction and Gala		EVENT DATE(S): April 5, 2025	
ARREST AND CONVICTION RECORD			
Since your 17th birthday, have you ever been convicted of a felony or misdemeanor? (Including criminal traffic offenses)			YES <input type="radio"/> NO <input checked="" type="radio"/>
As a juvenile, were you ever waived into adult court and convicted of a felony or misdemeanor?			YES <input type="radio"/> NO <input checked="" type="radio"/>
Have you ever been convicted by a military court-martial?			YES <input type="radio"/> NO <input checked="" type="radio"/>

Have you ever been convicted of disorderly conduct that involved violence against another person? YES NO

List any PENDING Citations, Tickets or Criminal Charges

YEAR	LOCATION	CHARGE	At time of incident were you under the influence of alcohol and/or other drugs?	Did the incident occur in or around a business that serves alcohol?

Criminal Convictions & Citations, Excluding Traffic Citations that are Not Alcohol Related

YEAR	LOCATION	CHARGE	At time of incident were you under the influence of alcohol and/or other drugs?	Did the incident occur in or around a business that serves alcohol?

I hereby agree to display and/or surrender my operator's license to any police officer or the State of Wisconsin for verification while I am working and further agree to abide by the State Statutes and local ordinances governing the sale of beer and intoxicating liquors. I hereby acknowledge being given and having read a copy of Wis. Stat. 125.32 (2) and (3). I give the Village of Somers permission to perform any necessary checks to verify the above statements. Under penalty of law, I swear that the information provided in this application is true and correct to the best of my knowledge and belief.

SIGNATURE OF APPLICANT <i>Amur P. Wasurul</i>	DATE <i>2.6.2015</i>
--	-------------------------

For Office Use Only

Date Paid	Amount Paid	Conditions: Education ___ Police ___ Fees ___
Clerk Approval	Date	Village Board Approval Date
License # Issued:		

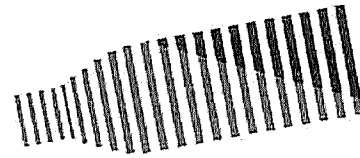

LIQUORexam.com

Where Knowledge Meets Responsibility

This certificate represents the successful completion of an approved Wisconsin Department of Revenue Responsible Beverage Server Course in compliance with secs. 125.04(5)(a)5., 125.17(6), and 134.66(2m), Wis. Stats.

CERTIFICATE OF COMPLETION

This is to certify that

Amber Wasurick

Has Successfully Completed the Following Course and Examination
Wisconsin Alcohol Server and Seller Certification

Edward D McLean

Edward D. McLean, Program Director
www.LIQUORexam.com



Date: 01/06/2025
Expiration: 24 Months
Certificate #: 211724
Birth Date: 08/24/1981

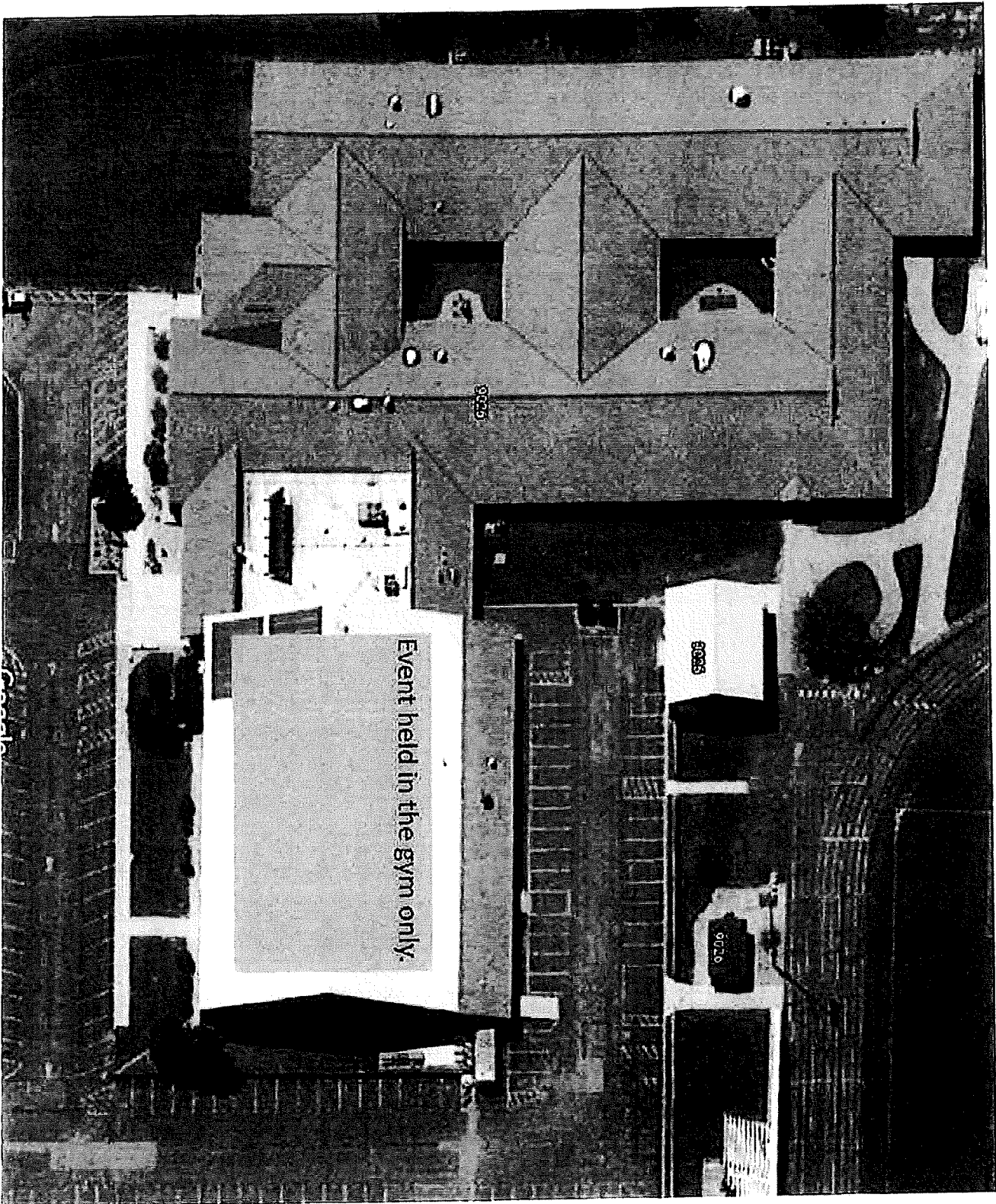



February 6, 2025

To Whom It May Concern (Town of Somers):

I understand that alcoholic beverages will be distributed at the Shoreland Lutheran High School event being held on Saturday, April 5th, 2025 from 4:30PM until 9:00PM. The event is a dinner auction to raise funds to support the increasing needs of our students.

I am hereby requesting a waiver allowing our school to serve alcohol under the conditions established and supervised by our planning committee. I am also requesting that you waive the fees for the Bartender License and the Class B License due to Shoreland Lutheran High School being a not-for-profit organization.

Proceeds from this event are used for program assistance, not for the profit of an individual or party.

Thank you for your consideration.

Sincerely,

A handwritten signature in black ink, appearing to read "Paul Scriver", with a long horizontal line extending to the right.

Paul Scriver
President

9026 12th Street - Kenosha, WI 53144
Phone: 262.859.2595



**VILLAGE OF SOMERS
VILLAGE BOARD
MEETING ITEM MEMORANDUM**

MEETING DATE: March 11, 2025

TO: Village President Stoner and Board of Trustees

PREPARED BY: Wendy Burnette Clerk-Treasurer

AGENDA ITEM: #17 Action on application for Special Event Permit from Elisabeth Pearson – Wedding/Reception, at the Girl Scouts of Wisconsin site located at 3901 1st St. Kenosha, WI 53144

BACKGROUND:

On February 24, 2025, Elisabeth Pearson applied for a special event permit for a Wedding/Reception to be held on May 24, 2025, at the Girl Scouts of Wisconsin site located at 3901 1st St. Kenosha, WI 53144.

This is a private event for guests of Elisabeth Pearson and will include food and entertainment.

PRIOR ACTION TAKEN:

This was discussed at the Marc 4, 2025 Village Work Session.

SUGGESTED ACTION/ACTION REQUESTED/COMMENTS:

Staff would recommend approval. In the event that the Village Board agrees with the suggested action, a suggested motion to approve would be as follows:

“Motion to approve application for Special Event Permit from Elisabeth Pearson – Wedding/Reception, at the Girl Scouts of Wisconsin site located at 3901 1st St. Kenosha, WI 53144 on May 24, 2025”

ATTACHMENTS:

Special Event Application w/ Site map

Lt. Adam Pisula Fire Inspection report for the Girl Scouts of Wisconsin site



Village of Somers
 P.O. Box 197
 7511 - 12th Street
 Somers, WI 53171
 262-859-2822

OFFICE USE ONLY
 DATE FILED: _____
 INITIALS: _____

Village of Somers Special Event Permit Single Event

Fee: \$75

Date(s) of Event: 5/24/2025 Hours of Event: Actual wedding 4p-11p
 Description of Event: WEDDING

Licensee Name: Elisabeth Pearson
Corporation, Partnership, or Individual

Trade/Event Name: Warfield Wedding

Trade/Event Address: 3901 1st St 53144
Street Zip

If Licensee is a Corporation or LLC, list Agent's Full Name: —

List Date of Birth of Agent (If Corporation/LLC) or Individual: 3-22-1996

Address: 1226 E Roberta Ave Waukesha WI 53186
Street City State Zip

Phone: 414 262-510-7778 Email: pearsonelisabeth0322@gmail.com
(Correspondence will be via email if address is given)

Driver's License Number: WI On File
State Number

1. Have you ever received any tickets or been charged with any crimes or felonies in any state? Yes No
 If yes, provide: Charge, State, Date, Result (including pending charges).
 (Examples: Speeding, WI, 5/8/2012, Guilty | Theft, FL, 5/22/2014, Dismissed | DUI, WI, 6/30/2017, Pending)

CHARGE	STATE	DATE	RESULT
Speeding	WI	7-3-2013	fine

2. Have you ever had your driver's license suspended or revoked in any state? Yes No
 If yes, provide: Charge, State, Date

CHARGE	STATE	DATE

3. Have you ever served or been sentenced to serve time in jail or prison in any state? Yes No
 If yes, provide: Charge, State, Date

CHARGE	STATE	DATE

4. Have you ever, while operating a business or engaged in a profession, been convicted of any charges involving unfair trade practices, unethical conduct, or discrimination in any state? Yes No
 If yes, provide: Charge, State, Date Result (Include pending charges).

CHARGE	STATE	DATE	RESULT

5. List the name and address of all employers for which you have worked and/or businesses you have operated in the past five (5) years. TRI-CITY Bank

201 E SUNSET DR, Waukesha WI 53186

6. Have you lived at your current home address for the past five (5) years? Yes No
 If no, please list all addresses which you have resided at in the past five (5) years.

READ CAREFULLY BEFORE SIGNING: Under penalty provided for by law, the undersigned states that each of the above questions has been truthfully answered to the best of his/her/their knowledge. False or incomplete answers will result in the denial/revocation of permit. (Individual applicants and each member of a partnership must sign; designed corporate officers must sign.)

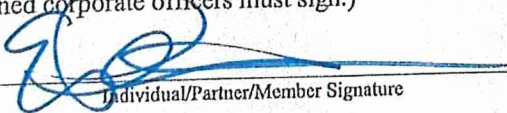
 Individual/Partner/Member Signature

2-22-2025
 Date

PLEASE NOTE: Attached as page 3 and 4 of the application is an **Operational and Security Plan**. This information is required. If not fully and accurately completed, the Special Event Permit application will be considered incomplete and will not proceed to any Committees for consideration until the information is provided.

PLEASE NOTE: Special Events Permits confer no rights regarding alcohol licensing, which must be obtained by separate application and approval.



www.somers.org P.O. Box 197, Somers, WI 53171

PH: (262) 859-2822

• FAX: (262) 859-2331 •

SPECIAL EVENT PERMIT (single Day): ALCOHOL BEVERAGE INFORMATION

To be completed by Agent of Event

Will you be selling or giving away Alcohol at this special event?

Selling _____
Giving Away

What types of alcohol beverages will be sold or given away liquor, beer, wine

If selling, please contact the clerk for alcohol permits, if you don't already have them.

Name, address and phone number of the responsible person or third-party vendor for alcohol beverages.

Elisabeth Pearson
1226 E Roberta Ave
Waukesha WI 53186

Bartenders must have a bartender's license in the Village of Somers. Please include a copy with this application.

If one is needed, please contact the Village of Somers to obtain a one-day event operator's license.

Individual/Partner/Member Signature

Date

* Having a signature drink that will be premade and served. Wine at tables.
No plan for a bartender.

SPECIAL EVENT PERMIT: OPERATIONAL AND SECURITY PLAN INFORMATION

Operational Plan

Legal occupancy limit for the premises: 128 persons

Attach scale drawing of parking plan

Number of off-street parking spaces used to service the premises: 0 parking spaces

Description of the off-street parking spaces used to service the premises: N/A

Describe the sound amplification equipment to be used (if any): AV system, built in to the lodge.

Attach drawing of where stage will be located. Will it be roped off? Please provide full details. -NO stage

Identify any sound mitigation strategies to be implemented: MUSIC, inside lodge no additional amplification.

How will orderly appearance and operation of the establishment be maintained in regard to litter and noise: _____

CEO of Girl Scouts and additional staff members will be onsite day of - the entire time.

Ceremony will be outside and remainder of event will be indoors in the lodge.

Attach scale drawing of elements of Security Plan

no security personnel due to nature of event.

Description of clothing to identify security personnel: CEO will have badge.

Are security personnel employees? If not, provide contact information for outside security firm: _____

Plan to handle control and clearance of the parking lot and public right-of-ways adjacent to licensed property during hours of operation and at closing time:

Event will end by 11 PM with a 15 minute window to stop music to have people out as close to that time as possible. Also, alcohol to stop being served no later than 30 min. prior.

How will the entrance line be managed and controlled:

No tickets or entry to event, therefore should not deal with bottleneck issues at entry.

Will any security personnel be armed? Yes No If yes, provide individual names and addresses

N/A

Plan for unruly patrons, intoxicated patrons, and physical disturbances (including fights):

Unruly behavior will not be tolerated and anyone that is not respecting the premise or neighbors would be ejected. It is a Girl Scout camp.

Underage drinking and fake ID plan:

No children at wedding with exception of a couple toddlers and CEO's 11-y.o. son.

Provide the first and last name of all management personnel:

Ana Simpson, C.E.O.
Kelly D'Amato-Turnquist, C.M.O.
- Both present day of event.

READ CAREFULLY BEFORE SIGNING: Under penalty provided for by law, the undersigned states that each of the above questions has been truthfully answered to the best of his/her/their knowledge.

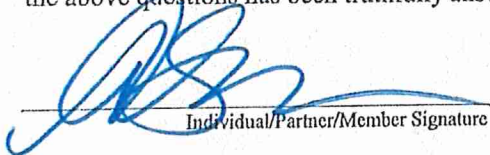
Individual/Partner/Member Signature

2-20-2025
Date

Inspection No:	20250228064
Inspection Date:	02/28/2025
Inspection Time:	0.34
Inspected By:	PISULA, ADAM

**SOMERS FIRE & RESCUE
FIRE INSPECTION REPORT**



Inspection and Compliance Orders

Facility:	Trefoil Oaks- Girl Scout Camp	Address:	3901 1st Street		
Phone:					
Fax:		City:	Somers		
Email:	kkopps@gswise.org	State:	WI	Postal Code:	53144

Primary Contact

Contact:	Kopps, kevin	Work:	414-687-5890		
Email:	kkopps@gswise.org	Cell:			

Inspection Type:	Inspection - General
-------------------------	----------------------

Violation Code	Days to Correct*	Violation	Notes	Location
----------------	------------------	-----------	-------	----------

Inspection Notes:

No violations found

Occupant : Kevin Kopps	
----------------------------------	---

* Number of days to correct from date inspected.

A variance procedure is available. Please contact the inspector named for further assistance with this or any other matter.



**VILLAGE OF SOMERS
VILLAGE BOARD
MEETING ITEM MEMORANDUM**

MEETING DATE: March 11th, 2025

TO: Village President Stoner and Village Trustees

PREPARED BY: Joshua Fugate, Utilities Manager

AGENDA ITEM: #18 Action on proposed Resolution No. 2025-004, A Resolution Authorizing Submittal of MS4 Report

BACKGROUND:

The attached Compliance Documents for Municipal Separate Storm Sewer System (MS4) Permits is a report filed annually with the DNR. The MS4 permit covers the Village's Municipal Separate Storm Sewer System. The Board must review and approve the report before it is filed through the DNR's online system.

The deadline to file this report is March 31st.

PRIOR ACTION TAKEN:

The Board reviewed and discussed this matter at our March 4th Work Session.

SUGGESTED ACTION/ACTION REQUESTED/COMMENTS:

The attached resolution approves the report and directs staff to file it with the DNR. Staff recommends approval. In the event that the Village Board agrees with the suggested action, a suggested motion to approve would be as follows:

“Motion to approve proposed Resolution 2025-004 regarding approval of MS4 Compliance Document and directing Staff to submit the same with DNR.”

ATTACHMENTS:

Resolution No. 2025-004 Authorizing Submittal of MS4 Report

Compliance Documents for Municipal Separate Storm Sewer System (MS4) Permits

RESOLUTION NO. 2025-004

WHEREAS, the Village of Somers is under the required Wisconsin Department of Natural Resources MS4 Permit; and

WHEREAS, the MS4 Permit has as a condition of continued compliance that the Village file an annual report; and

WHEREAS, the Annual Report has been made available to the Village Board for reviewing and viewing for the General Public through the Village Clerk/Treasurer; and

WHEREAS, the Annual Report by action of the Village Board has been adopted.

NOW THEREFORE be it resolved that the Village of Somers Village Board hereby authorize the submittal of the Annual MS4 Report.

VILLAGE OF SOMERS

By: _____
George Stoner, Village President

Attest: _____
Wendy Burnette, Village Clerk/Treasurer

This resolution has been passed by the Village Board of Trustees for the Village of Somers, Wisconsin, this _____ day of _____ 2025.

Submittal of Annual Reports and Other Compliance Documents for Municipal Separate Storm Sewer System (MS4) Permits

NOTE: Missing or incomplete fields are highlighted at the bottom of each page. You may save, close and return to your draft permit as often as necessary to complete your application. After 120 days your draft is **deleted**.

Form 3400-224(R8/2021)

Reporting Information :

Will you be completing the Annual Report or other submittal type? Annual Report Other

Project Name: 2024 Annual Report

County: Kenosha

Municipality: Somers, Village & Town

Permit Number: S050075

Facility Number: 31159

Reporting Year: 2024

Is this submittal also satisfying an Urban Nonpoint Source Grant funded deliverable? Yes No

Required Attachments and Supplemental Information

Please complete the contents of each tab to submit your MS4 permit compliance document. The information included in this checklist is necessary for a complete submittal. A complete and detailed submittal will help us review about your MS4 permit document. To help us make a decision in the shortest amount of time possible, the following information must be submitted:

Annual Report

- Review related web site and instructions for [Municipal storm water permit eReporting](#) [Exit Form]
- Complete all required fields on the annual report form and upload required attachments
- Attach the following other supporting documents as appropriate using the attachments tab above
 - Public Education and Outreach Annual Report Summary
 - Public Involvement and Participation Annual Report Summary
 - Illicit Discharge Detection and Elimination Annual Report Summary
 - Construction Site Pollution Control Annual Report Summary
 - Post-Construction Storm Water Management Annual Report Summary
 - Pollution Prevention Annual Report Summary
 - Leaf and Yard Waste Management
 - Municipal Facility (BMP) Inspection Report
 - Municipal Property SWPPP
 - Municipally Property Inspection Report
 - Winter Road Maintenance
 - Storm Sewer Map Annual Report Attachment
 - Storm Water Quality Management Annual Report Attachment
 - TMDL Attachment
 - Storm Water Consortium/Group Report

- Municipal Cooperation Attachment
- Other Annual Report Attachment

- Attach the following permit compliance documents as appropriate using the attachments tab above
 - Storm Water Management Program
 - Public Education and Outreach Program
 - Public Involvement and Participation Program
 - Illicit Discharge Detection and Elimination Program
 - Construction Site Pollutant Control Program
 - Post-Construction Storm Water Management Program
 - Pollution Prevention Program
 - Municipal Storm Water Management Facility (BMP) Inventory
 - Municipal Storm Water Management Facility (BMP) Inspection and Maintenance Plan
 - Total Maximum Daily Load documents (**if applicable, see permit for due dates.*)
 - TMDL Mapping*
 - TMDL Modeling*
 - TMDL Implementation Plan*
 - Fecal Coliform Screening Parameter *
 - Fecal Coliform Inventory and Map (*S050075-03 general permittees Appendix B B.5.2 – document due to the department by March 31, 2022*)
 - Fecal Coliform Source Elimination Plan (*S050075-03 general permittees Appendix B - document due to the department by October 31,2023*)

- Sign and Submit form

Municipal Contact Information- Complete

Notice: Pursuant to s. NR 216.07(8), Wis. Adm. Code, an owner or operator of a Municipal Separate Storm Sewer System (MS4) is required to submit an annual report to the Department of Natural Resources (Department) by March 31 of each year to report on activities for the previous calendar year ("reporting year"). This form is being provided by the Department for the user's convenience for reporting on activities undertaken in each reporting year of the permit term. Personal information collected will be used for administrative purposes and may be provided to the extent required by Wisconsin's Open Records Law [ss. 19.31-19.39, Wis. Stats.].

Note: Compliance items must be submitted using the Attachments tab.

Municipality Information

Name of Municipality: Somers, Village & Town

Facility ID # or (FIN): 31159

Updated Information: Check to update mailing address information

Mailing Address: 7511 12th Street

Mailing Address 2: P.O. Box 197

City: Somers, Village & Town

State: WI

Zip Code: 53171 xxxxx or xxxxx-xxxx

Primary Municipal Contact Person (Authorized Representative for MS4 Permit)

The "Authorized Representative" or "Authorized Municipal Contact" includes the municipal official that was charged with compliance and oversight of the permit conditions, and has signature authority for submitting permit documents to the Department (i.e., Mayor, Municipal Administrator, Director of Public Works, City Engineer).

Select to **create new** primary contact

First Name: Josh

Last Name: Fugate

Select to **update** current contact information

Title: Utilities Manager

Mailing Address: 7511 12th Street

Mailing Address 2: P.O. Box 197

City: Somers

State: WI

Zip Code: 53171 xxxxx or xxxxx-xxxx

Phone Number: 262-859-2822 Ext: xxx-xxx-xxxx

Email: jfugate@somers.org

Additional Contacts Information (Optional)

- I&E Program
- IDDE Program
- IDDE Response Procedure Manual

**Individual with responsibility for:
(Check all that apply)**

- Municipal-wide Water Quality Plan
- Ordinances
- Pollution Prevention Program
- Post-Construction Program
- Winter roadway maintenance

First Name: Josh

Last Name: Sullivan

Title: Superintendent

Mailing Address: 7511 12th Street

Mailing Address 2: P.O. Box 197

City: Somers

State: WI

Zip Code: 53171 xxxxx or xxxxx-xxxx

Phone Number: 262-859-2822 Ext: 103 xxx-xxx-xxxx

Email: jsullivan@somers.org

Municipal Billing Contact Person (Authorized Representative for MS4 Permit)

Select to **create new** Billing contact

First Name: Jason

Last Name: Peters

Select to **update** current contact information

Title: Administrator

Mailing Address: 7511 12th Street

Mailing Address 2: P.O. Box 197

City: Somers

State: WI

Zip Code: 53171 xxxxx or xxxxx-xxxx

Phone Number: 262-859-2822 Ext: xxx-xxx-xxxx

Email: jpeters@somers.org

1. Does the municipality rely on another entity to satisfy some of the permit requirements?

Yes No

Public Education and Outreach Root Pike Win Watershed Network

Public Involvement and Participation Root Pike Win Watershed Network

Illicit Discharge Detection and Elimination

Construction Site Pollutant Control

Post-Construction Storm Water Management _____

Pollution Prevention

2. Has there been any changes to the municipality's participation in group efforts towards permit compliances (i.e., the municipality has added or dropped consortium membership)?

Yes No

Minimum Control Measures- Section 1 : Complete

1. Public Education and Outreach

- a. Does MS4 conduct any educational efforts or events independently (not with a group) Yes No
- b. How many total educational events were held during the reporting year:
- c. Were any of the public education and outreach delivery mechanisms conducted during the reporting year active or interactive? Yes No
- d. Please select all storm water topics, target audiences, and delivery mechanisms used in the reporting year

Public Education and Outreach Delivery Mechanisms (Active and Passive)	
Active/Interactive Mechanisms	Passive Mechanisms
<input checked="" type="checkbox"/> Education activities (school presentations, summer camps) <input checked="" type="checkbox"/> Information booth at event <input checked="" type="checkbox"/> Targeted group training (contractors, consultants, etc.) <input type="checkbox"/> Government event (public hearing, council meeting) <input checked="" type="checkbox"/> Workshops <input type="checkbox"/> Tours <input type="checkbox"/> Other: <input type="text"/>	<input checked="" type="checkbox"/> Passive print media (brochures at front desk, posters, etc.) <input checked="" type="checkbox"/> Distribution of print media (mailings, newsletters, etc.) via mail or email. <input checked="" type="checkbox"/> Media offerings (radio and TV ads, press release, etc.) <input checked="" type="checkbox"/> Social media posts <input type="checkbox"/> Signage <input checked="" type="checkbox"/> Website <input type="checkbox"/> Other: <input type="text"/>

Topics Covered	Target Audience
<input checked="" type="checkbox"/> Illicit discharge detection and elimination <input checked="" type="checkbox"/> Household hazardous waste disposal/pet waste management/vehicle washing <input checked="" type="checkbox"/> Yard waste management/pesticide and fertilizer application <input checked="" type="checkbox"/> Stream and shoreline management <input checked="" type="checkbox"/> Residential infiltration <input checked="" type="checkbox"/> Construction sites and post-construction storm water management <input checked="" type="checkbox"/> Pollution prevention <input checked="" type="checkbox"/> Green infrastructure/low impact development <input type="checkbox"/> Other: <input type="text"/>	<input checked="" type="checkbox"/> General Public <input checked="" type="checkbox"/> Public Employees <input checked="" type="checkbox"/> Residents <input checked="" type="checkbox"/> Businesses <input checked="" type="checkbox"/> Contractors <input checked="" type="checkbox"/> Developers <input checked="" type="checkbox"/> Industries <input checked="" type="checkbox"/> Public Officials <input type="checkbox"/> Other: <input type="text"/>

- e. Will additional information/summary of these education events be attached to the annual report? Yes No

If no, please provide additional comment in the brief explanation box below. *Limit response to 250 characters and/or attach supplemental information on the attachments page.*

Minimum Control Measures - Section 2 : Complete**2. Public Involvement and Participation**

a. Permit Activities. Select all of the following topics the Permittee did to engage public participation and involvement.

Topics Covered	Target Audience	Estimated People Reached (Optional)	Regional Effort (Optional)
<input checked="" type="checkbox"/> MS4 Annual Report <input checked="" type="checkbox"/> Storm Water Management Program <input type="checkbox"/> Storm Water related ordinance <input type="checkbox"/> Other: <input type="text"/>	<input checked="" type="checkbox"/> General Public <input checked="" type="checkbox"/> Public Employees <input checked="" type="checkbox"/> Residents <input checked="" type="checkbox"/> Businesses <input checked="" type="checkbox"/> Contractors <input checked="" type="checkbox"/> Developers <input checked="" type="checkbox"/> Industries <input checked="" type="checkbox"/> Public Officials <input type="checkbox"/> Other	101 +	<input checked="" type="radio"/> Yes <input type="radio"/> No

b. Volunteer Activities. Select all of the following audiences targeted for volunteer involvement and participation related to storm water.

NA (Individual Permittee)

Topics Covered	Target Audience	Estimated People Reached (Optional)	Regional Effort (Optional)
Volunteer Opportunity	<input checked="" type="checkbox"/> General Public <input checked="" type="checkbox"/> Public Employees <input checked="" type="checkbox"/> Residents <input type="checkbox"/> Businesses <input checked="" type="checkbox"/> Contractors <input type="checkbox"/> Developers <input type="checkbox"/> Industries <input type="checkbox"/> Public Officials <input type="checkbox"/> Other	101 +	<input checked="" type="radio"/> Yes <input type="radio"/> No

c. Brief explanation on Public Involvement and Participation reporting. *Limit response to 250 characters and/or attach supplemental information on the attachments page.*

This education and outreach report and associated activities were produced and

executed by Root-Pike WIN's Respect Our Waters Program. Please contact the program manager with questions: laura@rootpikewin.org

Minimum Control Measures - Section 3 : Complete**3. Illicit Discharge Detection and Elimination**

a. How many total outfalls does the municipality have?
98 of 112

119

- b. How many major outfalls does the municipality have?
- c. How many outfalls did the municipality evaluate as part of their routine ongoing field screening program?
- d. From the municipality's routine screening, how many were confirmed illicit discharges?
-
- e. How many illicit discharge complaints did the municipality receive?
- f. From the complaints received, how many were confirmed illicit discharges?
-
- g. How many of the identified illicit discharges did the municipality eliminate in the reporting year (from both routine screening and complaints)?

(If the sum of 3.c. and 3.e. does not equal 3.f., please explain below.)

- h. What types of regulatory mechanisms does the municipality have available to compel compliance with this program? Check all that are available and how many times each were used in the reporting year.

- Verbal Warning
- Written Warning (including email)
- Notice of Violation
- Civil Penalty/ Citation

Additional Information: _____

- i. Brief explanation on Illicit Discharge Detection and Elimination reporting. *If you marked Unsure for any questions above, justify the reasoning. Limit response to 250 characters and/or attach supplemental information on the attachments page.*

N/A

Minimum Control Measures - Section 4 : Complete

4. Construction Site Pollutant Control

- a. How many total construction sites with one acre or more of land disturbing construction activity were active at any point in the reporting year?
- b. How many construction sites with one acre or more of land disturbing construction activity did the municipality issue permits for in the reporting year?
- c. How many erosion control inspections did the municipality complete in the reporting year (at sites with one acre or more of land disturbing construction activity)?
-
- d. What types of regulatory mechanisms does the municipality have available to compel compliance with this program? Check all that are available and how many times each were used in the reporting year.

<input checked="" type="checkbox"/> Verbal Warning	5
<input checked="" type="checkbox"/> Written Warning (including email)	4
<input checked="" type="checkbox"/> Notice of Violation	1
<input checked="" type="checkbox"/> Civil Penalty/ Citation	1
<input checked="" type="checkbox"/> Stop Work Order	1
<input checked="" type="checkbox"/> Forfeiture of Deposit	0
<input type="checkbox"/> Other - Describe below	0

e. Brief explanation on Construction Site Pollutant Control reporting . *If you marked Unsure for any questions above, justify the reasoning. Limit response to 250 characters and/or attach supplemental information on the attachments page.*

The civil penalty is in the amount of \$5,700 in Municipal Court. Report to be done once per month or a rain event of 0.5 inches or more. Inspections documented using form 4300-187

Minimum Control Measures - Section 5 : Complete

5. Post-Construction Storm Water Management

a. How many new structural storm water management Best Management Practice (BMP) have received local approval ? 0

*Engineered and constructed systems that are designed to provide storm water quality control such as wet detention ponds, constructed wetlands, infiltration basins, grassed swales, permeable pavement,

b. Does the MS4 have procedures for inspecting and maintaining private storm water facilities? Yes No

c. If Yes, how many privately owned storm water management facilities were inspected in the reporting year ? 0
Inspections completed by private landowners should be included in the reported number.

d. Does the municipality utilize privately owned storm water management BMP in its pollutant reduction analysis? Yes No

e. Does MS4 have maintenance authority on these privately owned BMPs?
 Yes No

f. What types of enforcement actions does the municipality have available to compel compliance with the regulatory mechanism? Check all that apply and enter the number of each used in the reporting year.

<input checked="" type="checkbox"/> Verbal Warning	0
<input checked="" type="checkbox"/> Written Warning (including email)	0
<input checked="" type="checkbox"/> Notice of Violation	0
<input checked="" type="checkbox"/> Civil Penalty/ Citation	0

<input type="checkbox"/> Forfeiture of Deposit	0
<input checked="" type="checkbox"/> Complete Maintenance	0
<input checked="" type="checkbox"/> Bill Responsible Party	0
<input type="checkbox"/> Other - Describe below	0

g. Brief explanation on Post-Construction Storm Water Management reporting. *If marked 'Unsure' on any questions above, justify your reasoning. Limit your response to 250 characters and/or attach supplemental information on the attachments page.*

Projects with new facilities enter into a Declaration of Stormwater Facilities plan as a part of DA. Since 2022 Village has allocated funds to obtain the depths of detention ponds, due to mild winters in the past 3 years testing has not taken place

Form 3400-224 (R8/2021)

Minimum Control Measures - Section 6 : Complete

6. Pollution Prevention

Storm Water Management Best Management Practice Inspections Not Applicable

a. Enter the total number of "municipally owned" (i.e., publicly owned BMPs) or operated (i. e., privately owned BMPs) structural storm water management best management practices. 4

b. How many new municipally owned storm water management best management practices were installed in the reporting year? 0

c. How many municipally owned (public) storm water management best management practices were inspected in the reporting year? 2

d. What elements are looked at during inspections (250 character limit)?
Basin integrity, invasive species removed, cleanliness, grate inspection

e. How many of these facilities required maintenance? 0

f. Brief explanation on Storm Water Management Best Management Practice inspection reporting. *If you marked Unsure for any questions above, justify the reasoning. Limit response to 250 characters and/or attach supplemental information on the attachments page.*

Public Works Yards & Other Municipally Owned Properties that require a stormwater pollution prevention plan (SWPPP)* Not Applicable

g. How many municipal properties require a SWPPP? 2

h. How many inspections of municipal properties have been conducted in the reporting year? 2

i. Have amendments to the SWPPPs been made?
 Yes No

If yes, describe what changes have been made. Limit response to 250 characters and/or attach supplemental information on the attachment page:

- k. Brief explanation on Storm Water Pollution Prevention Plan reporting. *If you marked Unsure for any questions above, justify the reasoning. Limit response to 250 characters and/or attach supplemental information on the attachments page.*

* Any municipally owned property that has the potential to generate stormwater pollution should have a SWPPP. For example, if a municipal property stores compost piles, material storage, yard wastes, etc., outside and can contaminate stormwater runoff—a SWPPP is required.

Collection Services - *Street Sweeping Program* Not Applicable

Collection Services - *Catch Basin Sump Cleaning Program* Not Applicable

- p. Did the municipality conduct catch basin sump cleaning during the reporting year? Yes No
- q. How many catch basin sumps were cleaned in the reporting year?
- r. If known, how many tons of material was collected?
- s. Does the municipality have a low hazard exemption for this material? Yes No
- t. If catch basin sump cleaning is identified as a storm water best management practice in the pollutant loading analysis, was cleaning completed at the assumed frequency?
- Yes- Explain frequency Village attempts to complete 45 per year
- No - Explain _____
- Not Applicable

Collection Services - *Leaf Collection Program* Not Applicable

- u. Does the municipality conduct curbside leaf collection? Yes No
- v. Does the municipality notify homeowners about pickup? Yes No
- w. Where are the residents directed to store the leaves for collection?
- Pile on terrace Pile in street Bags on terrace
- Other - Describe Yard Waste Disposal Site at Village/Town Hall
- x. What is the frequency of collection?
Site is open from Spring to late Fall
- y. Is collection followed by street sweeping? Yes No
- z. Brief explanation on Collection Services reporting. *Limit response to 250 characters and/or attach supplemental information on the attachments page*

Village tracks number of yard waste collected based on number of dumpsters filled throughout the season.

Winter Road Management Not Applicable

*Note: We are requesting information that goes beyond the reporting year, answer the best you can.

aa. How many lane-miles of roadway is the municipality responsible for doing snow and ice control? (One mile of a two-way road equals two lane miles.)

ab. Provide amount of de-icing products used by month last winter season?
Solids (tons) (ex. sand, or salt-sand)

Product	Oct	Nov	Dec	Jan	Feb	Mar
Salt	<input type="text" value="15"/>	<input type="text" value="22"/>	<input type="text" value="55"/>	<input type="text" value="38"/>	<input type="text" value="21"/>	<input type="text" value="0"/>
None	<input type="text"/>	<input type="text"/>	<input type="text"/>	<input type="text"/>	<input type="text"/>	<input type="text"/>

Liquids (gallons) (ex. brine)

	Oct	Nov	Dec	Jan	Feb	Mar
None	<input type="text"/>	<input type="text"/>	<input type="text"/>	<input type="text"/>	<input type="text"/>	<input type="text"/>

ac. Was salt applying machinery calibrated in the reporting year? Yes No

ad. Have municipal personnel attended salt reduction strategy training in the reporting year? Yes No

Training Date	Training Name	# Attendance
<input type="text"/>	<input type="text"/>	<input type="text"/>

ae. Brief explanation on Winter Road Management reporting. If you marked Unsure for any questions above, justify the reasoning. Limit response to 250 characters and/or attach supplemental information on the attachments page

Internal (Staff) Education & Communication

af. Has the municipality provided an opportunity for internal training or education to staff implementing the municipality's procedures for each of the pollution prevention program element? Yes No

If yes, describe what training was provided (250 character limit):

ag. Describe how the municipality has kept the following local officials and municipal staff aware of the municipal storm water discharge permit programs, procedures and pollution prevention program requirements.

Elected Officials

Municipal Officials

Appropriate Staff (such as operators, Department heads, and those that interact with public)

- ah. Brief explanation on Internal Education reporting. *If you marked Unsure for any questions above, justify the reasoning. Limit response to 250 characters and/or attach supplemental information on the attachments page.*

Appropriate staff given copies of Somers Storm Water Management Program.

Form 3400-224 (R8/2021)

Minimum Control Measures - Section 7 : Complete

7. Storm Sewer System Map

- a. Did the municipality update their storm sewer map this year?

Yes No

If yes, check the areas the map items that got updated or changed:

- Storm water treatment facilities
 Storm pipes
 Vegetated swales
 Outfalls
 Other - Describe below

- b. Brief explanation on Storm Sewer System Map reporting. *If you marked Unsure for an question for any questions above, justify the reasoning. Limit response to 250 characters and/or attach supplemental information on the attachments page.*

GPS of manholes, culverts, storm basins, etc has been updated. Waiting on consultant to incorporate new data into GIS Mapping. Mapping of outfalls and inspection frequencies for each

Final Evaluation - Complete

Fiscal Analysis

Complete the fiscal analysis table provided below. For municipalities that do not break out funding into permit program elements, please enter the monetary amount to your best estimate of what funding may be going towards these programs.

Annual Expenditure Reporting Year	Budget Reporting Year	Budget Upcoming Year	Source of Funds
-----------------------------------	-----------------------	----------------------	-----------------

Element: Public Education and Outreach

1192	1192	1200	<u>Storm water utility</u>
------	------	------	----------------------------

Element: Public Involvement and Participation

1192	1192	1200	<u>Storm water utility</u>
------	------	------	----------------------------

Element: Illicit Discharge Detection and Elimination

100	100	100	<u>Storm water utility</u>
-----	-----	-----	----------------------------

Element: Construction Site Pollutant Control

300	300	1000	<u>Storm water utility</u>
-----	-----	------	----------------------------

Element: Post-Construction Storm Water Management

2000	2000	2000	<u>Storm water utility</u>
------	------	------	----------------------------

Element: Pollution Prevention

1000	1000	1000	<u>Storm water utility</u>
------	------	------	----------------------------

Other (describe)

			<u>Select...</u>
--	--	--	------------------

Please provide a justification for a "0" entered in the Fiscal Analysis. *Limit response to 250 characters.*

Water Quality

a: Were there any known water quality improvements in the receiving waters to which the municipality's storm sewer system directly discharges to?

- Yes No Unsure If Yes, explain below:

b: Were there any known water quality degradation in the receiving waters to which the municipality's storm sewer system directly discharges to?

- Yes No Unsure If Yes, explain below:

c: Have any of the receiving waters that the municipality discharges to been added to the impaired waters list during the reporting year?

Yes No Unsure

d: Has the municipality evaluated their storm water practices to reduce the pollutants of concern?

Yes No Unsure

Storm Water Quality Management

a. Has the municipality completed or updated modeling in the reporting year (relating to developed urban area performance standards of s. NR 151.13(2)(b)1., Wis. Adm. Code)? Yes No

b. If yes, enter percent reduction in the annual average mass discharging from the entire MS4 to surface waters of the state as compared to implementing no storm water management controls:

Total suspended solids (TSS)

Total phosphorus (TP)

Additional Information

Based on the municipality's storm water program evaluation, describe any proposed changes to the municipality's storm water program. *If your response exceeds the 250 character limit, attach supplemental information on the attachments page.*

Requests for Assistance on Understanding Permit Programs

Would the municipality like the Department to contact them about providing more information on understanding any of the Municipal Separate Storm Sewer Permit programs?

Please select all that apply:

- Public Education and Outreach
- Public Involvement and Participation
- Illicit Discharge Detection and Elimination
- Construction Site Pollutant Control
- Post-Construction Storm Water Management
- Pollution Prevention
- Storm Water Quality Management
- Storm Sewer System Map
- Water Quality Concerns
- Compliance Schedule Items Due
- MS4 Program Evaluation

Required Attachments and Supplemental Information

Any other MS4 program information for inclusion in the Annual Report may be attached on here. Use the Add Additional Attachments to add multiple documents.

Upload Required Attachments (15 MB per file limit) - [Help reduce file size and trouble shoot file uploads](#)

*Required Item

Note: To replace an existing file, use the 'Click here to attach file ' link or press the to delete an item.

Storm Sewer System Map

 File Attachment

[2025.02.05 Village & Town of Somers Storm Map.pdf](#)

Attach - Other Supporting Documents

AR EO

 File Attachment

[MS4 Report Write-In - Somers.pdf](#)

AR IP

 File Attachment

[2024 Photo Recap - Somers.pdf](#)

AR EO

 File Attachment

[2024 Synopsis - Somers.xlsx](#)

AR MuniSWPPP

 File Attachment

[2025 PW SWPPP Inspection Form.pdf](#)

AR EO

 File Attachment

[2024.02.02 ADM DNR 2023 MS4 Survey Results - ROW 2023 - Village and Town of Somers.pdf](#)

AR BMPInspSum

 File Attachment

[stormwaterponds-final.pdf](#)

(To remove items, use your cursor to hover over the attachment section. When the drop down arrow appears, select remove item)

Attach - Permit Compliance Documents

PP BMPInsp

 File Attachment

[2024 Somers Storm Water Management Program combined.pdf](#)

PP BMPInsp

 File Attachment

[Storm Water Pollution Prevention Planning Outline.pdf](#)

IDDE Program

 File Attachment

[2025 ADM DNR 2022 MS4 Somers Storm Water Management Program Section 4 - Illicit Discharge Detection and Elimination Appendix B C.pdf](#)

CS Program

 File Attachment

[Chapter 17 Construction Site Erosion and Sediment Control.pdf](#)

PP BMPInventory

 File Attachment

[2024.03.20 ADM DNR 2023 MS4 Somers No Exposure Certification for Public Works Facility 3-20-24.pdf](#)

CS Program

 File Attachment

[2024.03.14 ADM DNR 2023 MS4 Somers Storm Water Management Program Section 5 - Construction Site Pollutant Control Appendix D.pdf](#)

CS Program

 File Attachment

[2023.10.16 DNR MS4 2023 LTR DNR Repsonse Executed.pdf](#)

IDDE Program

 File Attachment

[2025 PW Illegal Connection or Illicit Discharge Form FILLABLE.pdf](#)

IDDE Program

 File Attachment

[IDDE Written Program Procedure.pdf](#)

PP BMPInsp

 File Attachment

[MS4 Outfall Screening List.pdf](#)

PP BMPInsp

 File Attachment

[Written Program Procedure for Municipally Owned Dry Ponds.pdf](#)

PP BMPInsp

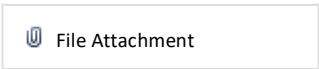

[SWPPP Somers Final \(1\).pdf](#)

(To remove items, use your cursor to hover over the attachment section. When the drop down arrow appears, select remove item)

Sign and Submit Your Application

Steps to Complete the signature process

1. Read and Accept the Terms and Conditions
2. Press the Submit and Send to the DNR button

NOTE: For security purposes all email correspondence will be sent to the address you used when registering your WAMS ID. This may be a different email than that provided in the application. For information on your WAMS account click [HERE](#).

Terms and Conditions

Certification: I hereby certify that I am an authorized representative of the municipality covered under Somers, Village & Town MS4 Permit for which this annual report or other compliance document is being submitted, and that the information contained in this submittal and all attachments were gathered and prepared under my direction or supervision. Based on my inquiry of the person or persons under my direction or supervision involved in the preparation of this document, to the best of my knowledge, the information is true, accurate, and complete. I further certify that the municipality's governing body or delegated representatives have reviewed or been apprised of the contents of this annual report. I understand that Wisconsin law provides severe penalties for submitting false information.

Signee (must check current role prior to accepting terms and conditions)

- Authorized municipal contact using WAMS ID.
- Delegation of Signature Authority (Form 3400-220) for agent signing on the behalf of the authorized municipal contact.
- Agent seeking to share this item with authorized municipal contact (authorized municipal contact must get WAMS id and complete signature).

Name: Josh Fugate

Title: Utilities Manager

Authorized Signature.

- I accept the above terms and conditions.

Signed by : i:0#.f|wamsmembership|jfugate65 on 2025-02-11T10:09:06

You have already signed and submitted this application to the DNR. Please [contact the Wisconsin DNR](#) for assistance.

After providing the final authorized signature, the system will send an email to the authorized party and any agents. This email will include a copy to the final read only version of this application.



**VILLAGE OF SOMERS
VILLAGE BOARD
MEETING ITEM MEMORANDUM**

MEETING DATE: March 11th, 2025

TO: Village President Stoner and Village Trustees

PREPARED BY: Wendy Burnette-Clerk/Treasurer

AGENDA ITEM: #19 Action on Operator's Licenses: Coleton Hanna and William Valencia

BACKGROUND:

Coleton Hanna and William Valencia have applied for operator's licenses for the Village of Somers.

No discrepancies with these applications.

SUGGESTED ACTION/ACTION REQUESTED/COMMENTS:

Staff recommends approval. In the event that the Village Board agrees with the recommendation to approve: Operators applications, a suggested motion would be as follows:

"Motion to approve Operator License for Coleton Hanna and William Valencia"

ATTACHMENTS:

None